

RADIO COMMUNICATIONS TEST SET 2955B

Part no. 52955-500J

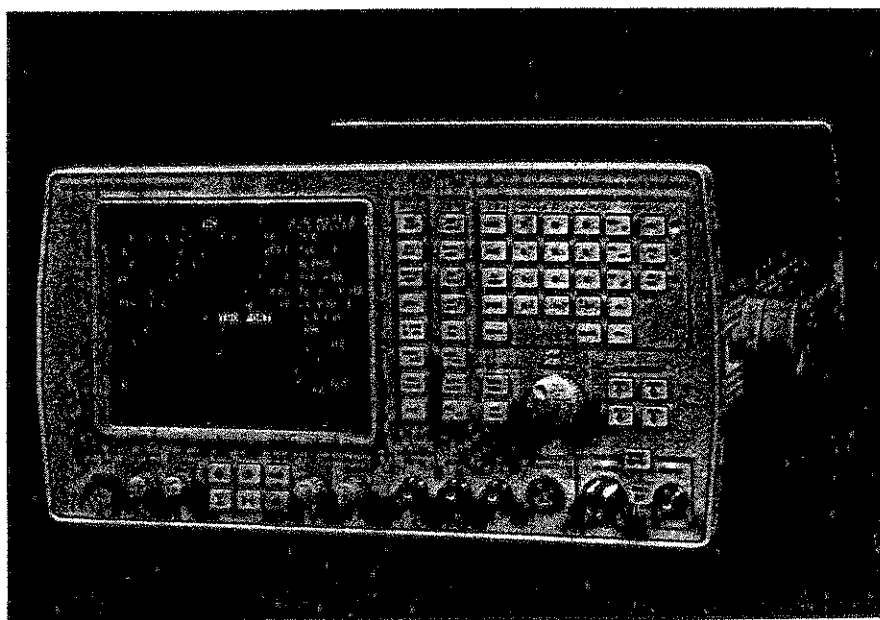

Manual part no. 46882-113R
Issue 2

CONTENTS

	Page
Preface	vi
German RFI Declaration for Class B Self-certification	viii
Operating precautions	ix
Compatibility with 2955, 2955A and 2955R	xi
Chapter 1 GENERAL INFORMATION	1-1
Introduction	1-3
Special features	1-6
Transmitter testing	1-6
Receiver testing	1-6
Duplex testing	1-7
Performance data	1-8
RF signal generator	1-8
Modulation generator	1-9
AF generators	1-11
RF frequency meter	1-12
RF power meter	1-12
Modulation meter	1-13
Distortion and noise meter	1-15
AF frequency meter	1-16
AF voltmeter	1-16
Internal frequency standard	1-17
Digital storage oscilloscope	1-17
Selcall (sequential tone) encoder and decoder	1-18
Additional features	1-18
Off-air receiver (Option 1 only)	1-21
General	1-21
Accessories	1-23
Supplied	1-23
Optional	1-23
Chapter 2 INSTALLATION	2-1
Unpacking and repacking	2-1
GPIB and serial interface units	2-2
Mounting arrangements	2-3
Rack mounting	2-3
Battery pack	2-3
Safety testing	2-4
Power requirements	2-4
Acceptance testing	2-5
Connections	2-6
Accessory in/out socket	2-7
RF in/out socket	2-8

CONTENTS continued

	Page
Chapter 3 LOCAL OPERATION	3-1
Introduction to operation	3-4
General	3-4
Initial settings	3-4
Self testing	3-4
Selecting the measurement mode	3-4
Front panel	3-5
Rear panel	3-7
Accessories	3-8
Transmitter testing	3-9
AF generators	3-9
RF power meter	3-14
Modulation meter	3-16
Distortion and noise meter	3-19
Applications	3-21
Receiver testing	3-22
RF generator	3-22
AF voltmeter	3-29
Distortion and noise meter	3-31
Duplex testing	3-34
Controls and connectors	3-34
Operation	3-35
Tones menu	3-37
Modulation and AF setup	3-37
Audio testing	3-39
AF generators	3-39
AF voltmeter	3-44
Distortion meter	3-46
Signalling codes testing	3-48
Controls and connectors	3-48
Sequential tones operation	3-50
Revertive sequential tones operation	3-59
DTMF (dual-tone multi-frequency) operation	3-61
DCS (digitally-coded squelch) operation	3-64
POCSAG radio pager testing	3-67
Help key operation	3-69
Help key	3-69
Operating summaries	3-69
Parameters	3-71
Self testing	3-73
Transmitter monitoring (Option 1 only)	3-76
Controls and connectors	3-76
Operation	3-78
Store and recall operation	3-84
Introduction	3-84
Store procedure	3-84
Recall procedure	3-85

CONTENTS continued

	Page
Printer operation	3-86
Introduction	3-86
Power supplies	3-86
GPIB connections	3-86
Printing	3-86
Chapter 4 REMOTE OPERATION	4-1
GPIB interface unit	4-3
Introduction	4-3
Switch settings	4-3
Display	4-4
Serial interface unit	4-5
Introduction	4-5
Switch settings	4-5
Display	4-6
Local commands	4-6
Commands for the 2955B	4-7
Introduction	4-7
Syntax	4-7
Command codes	4-9
Command codes for keys	4-9
Other command codes	4-9
ASCII codes	4-9
Summary	4-9
Writing a program	4-23
Operating example	4-23
GPIB Controller programs	4-23
Computer programs	4-24
Command input	4-24
Data output	4-24
Status byte and service requests	4-25
Creating a screen display	4-25
Chapter 5 BRIEF TECHNICAL DESCRIPTION	5-1
Introduction	5-1
RF signal generator	5-2
AF voltmeter	5-3
AF generators	5-4
RF power meter	5-5
Modulation meter	5-6
Distortion and noise meter	5-8
Sensitive receiver	5-10

CONTENTS continued

		Page
Chapter 6	ACCEPTANCE TESTING	6-1
	Testing	6-2
	Oscilloscope	6-2
	Modulation meter	6-6
	Voltmeter	6-11
	RF frequency meter	6-13
	AF frequency meter	6-15
	AF generators	6-16
	DTMF encoder and decoder	6-21
	Distortion and noise meter	6-22
	RF power meter	6-23
	Sequential tones	6-25
	RF generator	6-26
	Sensitive off-air receiver	6-36
Index		Ind. 1

ASSOCIATED PUBLICATIONS

	Part No.
Introductory Guide 46882-115K
Service Manual 46882-114B

PREFACE

SOFTWARE

This Manual covers instruments which contain software version 2. If any later version affects this Manual, a Change sheet will be supplied.

INSTRUMENT VERSIONS

There are different versions of the 2955B as follows:-

Ordering number	Feature
Option 1	Sensitive Off-air Receiver fitted.
Option 2	GPIB Interface Unit omitted.
Option 3	Serial Interface Unit fitted.
Option 4	French.
Option 5	Spanish.
Option 6	DC Supply Unit fitted and Front Stowage Cover supplied.

The French and Spanish versions are identical to the English versions except for the language on displays and on legends except where otherwise stated.





A GPIB Interface Unit (as without Option 2) or a Serial Interface Unit (as Option 3) can be retrofitted. See under 'Optional Accessories'.

AMENDMENT STATUS

Each page bears the date of its original issue or the date and number of the latest amendment. Any changes subsequent to the latest amendment are included on Manual Change sheets coded C1, C2 etc.

HAZARD SYMBOLS

The following symbols appear on this equipment.

Symbol	Type of hazard	Reference in Manual
	Dangerous voltages	Page ix
	Cathode ray tube	Page ix
 or 	Static-sensitive components	Page ix
 C0285	Input overload	Page x

PREFACE continued

WARNINGS, CAUTIONS AND NOTES

The following terms have specific meanings in this Manual.

WARNINGS contain information to prevent personal injury.

CAUTIONS contain information to prevent damage to the equipment.

Notes contain important general information.

GERMAN RFI DECLARATION FOR CLASS B SELF-CERTIFICATION

Hiermit wird bescheinigt, dass der Radio Communications Test Set 2955B in Übereinstimmung mit den Bestimmungen der Vfg 1046/1984 funk-entstört ist.

Der Deutschen Bundespost wurde das Inverkehrbringen dieses Gerätes angezeigt und die Berechtigung zur Überprüfung der Serie auf Einhaltung der Bestimmungen eingeräumt.

**Marconi Instruments Ltd., Longacres, St. Albans
Hertfordshire, AL4 0JN, UK**

English translation:

We hereby certify that the Radio Communications Test Set 2955B complies with the RFI suppression requirements of Vfg 1046/1984. The German Postal Service was notified that equipment is being marketed. The German Postal Service has the right to re-test the equipment and verify compliance.

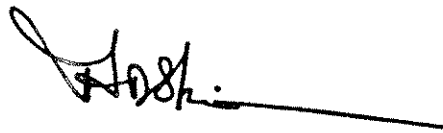

Signed

A D SKINNER

Head of Measurement Standards

OPERATING PRECAUTIONS

This product has been designed and tested in accordance with IEC Publication 348 - 'Safety Requirements for Electronic Measuring Apparatus'. To keep it in a safe condition and avoid risk of injury, the precautions detailed in the WARNINGS below should be observed. To avoid damage to the equipment the precautions detailed in the CAUTIONS should also be observed.

WARNING - ELECTRICAL HAZARDS

AC supply voltage. This equipment conforms with IEC Safety Class 1, meaning that it is provided with a protective earthing lead. To maintain this protection the mains supply lead must always be connected to the source of supply via a socket with an earthing contact. Make sure that the earth protection is not interrupted if the supply is connected through an extension lead or an autotransformer.

Before fitting a non-soldered plug to the mains lead cut off the tinned end of the wires, otherwise cold flowing of the solder could cause intermittent contact.

Do not use the equipment if it is likely that its protection has been impaired as a result of damage.

Fuses. Note that there is a supply fuse in both the live and neutral wires of the supply lead. If only one of these fuses should rupture, certain parts of the equipment could remain at supply potential.

Make sure that only fuses of the correct rating and type are used for replacement. Do not use mended fuses or short-circuited fuse holders.

To provide protection against breakdown of the supply lead, its connectors (and filter if fitted), an external supply fuse with a continuous rating not exceeding 6 A should be used in the live conductor (e.g. fitted in the supply plug).

Removal of covers. Disconnect the supply before removing the covers so as to avoid the risk of exposing high voltage parts. If any internal adjustment or servicing has to be carried out with the supply on, it must only be performed by a skilled person who is aware of the hazard involved.

Remember that capacitors inside the equipment, including any supply filter capacitors, may still be charged after disconnection of the supply. Those connected to high voltage points should be discharged before carrying out work inside the equipment.

This applies particularly to the EHT circuit for the cathode ray tube which must be discharged by repeatedly shorting the final anode lead to the chassis or by using a bleed resistor. The residual charge on the CRT itself should also be removed by shorting the anode connector to the chassis.

WARNING - OTHER HAZARDS

Parts of this equipment are made from metal pressings, therefore it should be handled with due care to avoid the risk of cuts or scratches.

Some of the components used in this equipment may include resins and other materials which give off toxic fumes if incinerated. Take appropriate precautions, therefore, in the disposal of these items.

Cathode ray tube. When exposing or handling the tube, take care to prevent implosion and possible scattering of glass fragments. Handling should only be carried out by experienced personnel and the use of a safety mask and gloves is recommended. A defective tube should be disposed of in a safe manner by an authorized waste contractor.

CAUTION - STATIC SENSITIVE COMPONENTS

This equipment contains static-sensitive components which may be damaged by handling. Refer to the Service Manual for handling precautions.

OPERATING PRECAUTIONS continued

CAUTION - INPUT OVERLOAD

When testing a transmitter, an input overload is indicated by the message 'REMOVE RF INPUT' and an audible warning. Failure to respond could result in damage to the equipment.

CAUTION - TILT FACILITY

When the instrument is in the tilt position, it is inadvisable, for stability reasons, to stack other instruments on top of it.

COMPATIBILITY WITH 2955, 2955A and 2955R

The 2955 was superseded by the 2955A and 2955R. In turn, these were superseded by the 2955B. If you are familiar with an earlier model, you should note the following differences:-

Chapter 1

- (1) The 2955 has RF signal generator output level ranges which are 5 dB lower than those of the other models. Therefore, the lowest possible setting is 5 dB higher on the 2955A, 2955R and 2955B. See under 'Performance data'.

Chapter 3

- (1) On the 2955, 2955A and 2955R, the front panel keys are coloured blue, green, orange, white and brown. On the 2955B, the lettering on the keys is the same colour except for dark grey instead of white and brown.
- (2) The fifth and sixth blue MODE keys are different as follows:-

Key	2955	2955A	2955R & 2955B
Fifth	BAR CHART	Blank	TX MON ON-OFF
Sixth	SCOPE	SCOPE/BAR	SCOPE/BAR

If the 2955B Option 1 is not fitted, a message is displayed when the TX MON ON-OFF key is used. See under 'Front panel'.

- (3) The fifth green FUNCTION key is different. On the 2955, this key is marked MOD ON-OFF. On the 2955A, 2955R and 2955B, this key is marked ON OFF because it is used for RF and AF generators in addition to modulation.
- (4) On the 2955, there are 37 stores. On the 2955A, 2955R and 2955B, there are 26 stores which each has a larger capacity. With early software, the 2955A appeared to accept numbers higher than 26 but this was corrected from software issue 6. See under 'Front panel'.
- (5) The 2955 has one variable AF/modulation generator which is set by using AF GEN and SET MOD. The 2955A, 2955R and 2955B have two fully-variable AF/modulation generators. See under 'AF generators' and 'RF generator'.
- (6) On the 2955, TWO TONES and SUB-AUDIBLE are selected on the TONES STANDARD MENU. On the 2955A, 2955R and 2955B, these are generated by using the second AF generator as selected on the main display.
- (7) In the DUPLEX test mode on the 2955, the modulation frequency is automatically set to 1 kHz. On the 2955A, 2955R and 2955B, if any other modulation frequency has been set in the DUPLEX mode, this is retained if the DUPLEX mode is re-selected after using another mode. The modulation frequency is changed to 1 kHz when distortion or SINAD is selected.
- (8) On the 2955, there is one page of sequential tones. On the 2955A, 2955R and 2955B, there are three pages which allow up to 33 tones to be used. Each page of 11 tones is selected by the NEXT PAGE soft key. See under 'Sequential tones operation'.

- (9) On the 2955, the fifth from last sequential tone can be extended. On the 2955A, 2955R and 2955B, any one of the sequential tones can be extended. See under 'Sequential tones operation'.
- (10) On the 2955B only, user-defined tones can be set up through a COPY TONES MENU which is provided to facilitate adaption from an existing standard. See under 'Sequential tones operation'.
- (11) On the 2955A, there are six settings under CHANGE PARAMETERS on the HELP menu. On the 2955A, 2955R and 2955B, there are six more settings. See under 'Parameters'.
- (12) As supplied, each 2955 is programmed either for EEA (European) or for EIA (North American). On the 2955A, 2955R and 2955B, this is selected under CHANGE PARAMETERS on the HELP menu. See TONE STANDARD selection under 'Parameters'.
- (13) For use in the GPIB mode with a Cellular or Multi-system Adapter or when using GPIB software which has been written for the 2955, a later model can be set to emulate the 2955. See GPIB MODE selection under 'Parameters'.
- (14) On the 2955B only, the TRANSMITTER MONITOR mode has start and step tuning and selected frequencies tuning in addition to manual tuning. These extra facilities are selected by means of a TX MONITOR MODE SELECTION MENU. See under 'Transmitter monitoring (Option 1 only)'.
- (15) On the 2955B only, a STORE/RECALL MENU is provided so that each set of stored settings can be given a title. See under 'Store and recall operation'.

Chapter 4

- (1) The fifth and sixth blue MODE keys have different command codes as follows:-

Key	2955	2955A, 2955R & 2955B
Fifth	BC (for BAR CHART)	TM (for TX MON ON-OFF)
Sixth	SC (for SCOPE)	SC and BR (for SCOPE/BAR)

If soft key codes XE and XF have been used in 2955 software for this function, then these have to be changed to BC and SC for use with the 2955A, 2955R and 2955B

- (2) On the 2955, the command code for the fifth green FUNCTION key is MD (for MOD ON-OFF). On the 2955A, 2955R and 2955B, the command code NF (for ON OFF) is used in place of MD but MD can still be used for compatibility with the 2955.
- (3) On the 2955, command RD25 is 'read sequential tone 12'. On the 2955A, 2955R and 2955B, command RD25 is 'read the sequential tone page number'. This is because of the 3 pages of 11 tones each.
- (4) Because of improved tones/signalling capability, the 2955A, 2955R and 2955B have an extra menu for sequential tones. Therefore, command code XB for SEQUENTIAL is added after the TN for TONES. On the SEQUENTIAL TONES menus, XB to XF on the 2955 are changed to XA to XE on the other models.
- (5) For self-testing on the 2955A, 2955R or 2955B, the user can decide to select NEXT TEST or ALL TESTS. Therefore, command code XA for NEXT TEST and XF for ALL TESTS are added under SELF TEST.

- (6) On the 2955, store 37 is used with a Cellular or Multi-system Adapter. On the 2955A, 2955R and 2955B, store 26 is used instead.
- (7) Addresses for peek (PE) and poke (PO) are different. When these have been used, refer to a Marconi Instruments representative for new information.
- (8) In the character generators, characters 10, 15, 16, 17, 27, 61 and 125 (decimal) are different to allow for enhanced displays. See 2955 Operating Manual Fig. 3-17, 2955A & 2955R Programming Manual Fig. 3-2 or 2955B Operating Manual Fig. 4-6.
- (9) On the 2955R, the command TM1 is used to enter the TRANSMITTER MONITOR mode display. This also applies to the 2955B for manual tuning. This is equivalent to using XE and XB on the 2955B. On the 2955R, the command TM0 is used to return to the previous mode. This also applies to the 2955B. This is equivalent to using XE in one of the TRANSMITTER MONITOR mode displays.

Chapter 1

GENERAL INFORMATION

	Page
Introduction	1-3
Special features	
TRANSMITTER TESTING	1-6
RECEIVER TESTING... ..	1-6
DUPLEX TESTING	1-7
Performance data	
RF SIGNAL GENERATOR	1-8
Output impedance	1-8
Frequency	1-8
Output level	1-8
Spectral purity	1-8
Protection	1-9
CW on/off key	1-9
MODULATION GENERATOR... ..	1-9
Amplitude modulation	1-9
AM external input	1-10
Frequency modulation	1-10
FM external input	1-10
Phase modulation	1-10
ΦM external input	1-11
AF GENERATORS	1-11
Two tone	1-11
Output impedance	1-11
Frequency	1-11
Shape	1-11
Output level (EMF)	1-11
Signal purity (sine only)	1-12
RF FREQUENCY METER	1-12
Frequency	1-12
Input	1-12
RF POWER METER	1-12
Input	1-12
MODULATION METER	1-13
Input	1-13
Amplitude modulation	1-14
Frequency modulation	1-14
Phase modulation	1-15
DISTORTION AND NOISE METER	1-15
Distortion	1-15
S/N	1-15
SINAD	1-16
AF FREQUENCY METER	1-16
General	1-16

	Page
AF VOLTMETER	1-16
General	1-16
INTERNAL FREQUENCY STANDARD	1-17
Oven-controlled crystal oscillator	1-17
DIGITAL STORAGE OSCILLOSCOPE	1-17
General	1-17
SELCALL (SEQUENTIAL TONE) ENCODER AND DECODER	1-18
General	1-18
ADDITIONAL FEATURES	1-18
IF output socket... ..	1-18
Demodulation output socket	1-18
Accessory socket	1-19
DTMF encoder and decoder	1-19
Pager testing	1-19
DCS encoding	1-19
DCS decoding	1-19
External modulation measurement	1-19
Special key functions	1-19
Miscellaneous	1-20
Remote control	1-20
GPIB	1-20
OFF-AIR RECEIVER (Option 1 only)... ..	1-21
General	1-21
GENERAL... ..	1-21
AC power requirements	1-21
DC power requirements (Option 6 only)	1-21
Radio frequency interference	1-21
Safety	1-22
Environmental	1-22
Conditions of storage and transport	1-22
Dimensions and weight	1-22

Accessories

SUPPLIED... ..	1-23
OPTIONAL	1-23

Introduction

Radio Communications Test Set type 2955B combines all the measurement facilities required for testing mobile radio transceivers in the range up to 1000 MHz. It is a compact self-contained unit designed for bench or mobile use and can be considered as a combination of the following instruments:-

- RF frequency meter.
- AF frequency meter.
- RF signal generator.
- AF generators (two).
- RF power meter.
- AF and DC voltmeter.
- Modulation meter.
- AF distortion, S/N or SINAD meter.
- Digital storage oscilloscope.
- Sequential tones decoder and encoder.
- DTMF decoder and encoder.
- DCS decoder and encoder.
- POCSAG radio pager encoder.

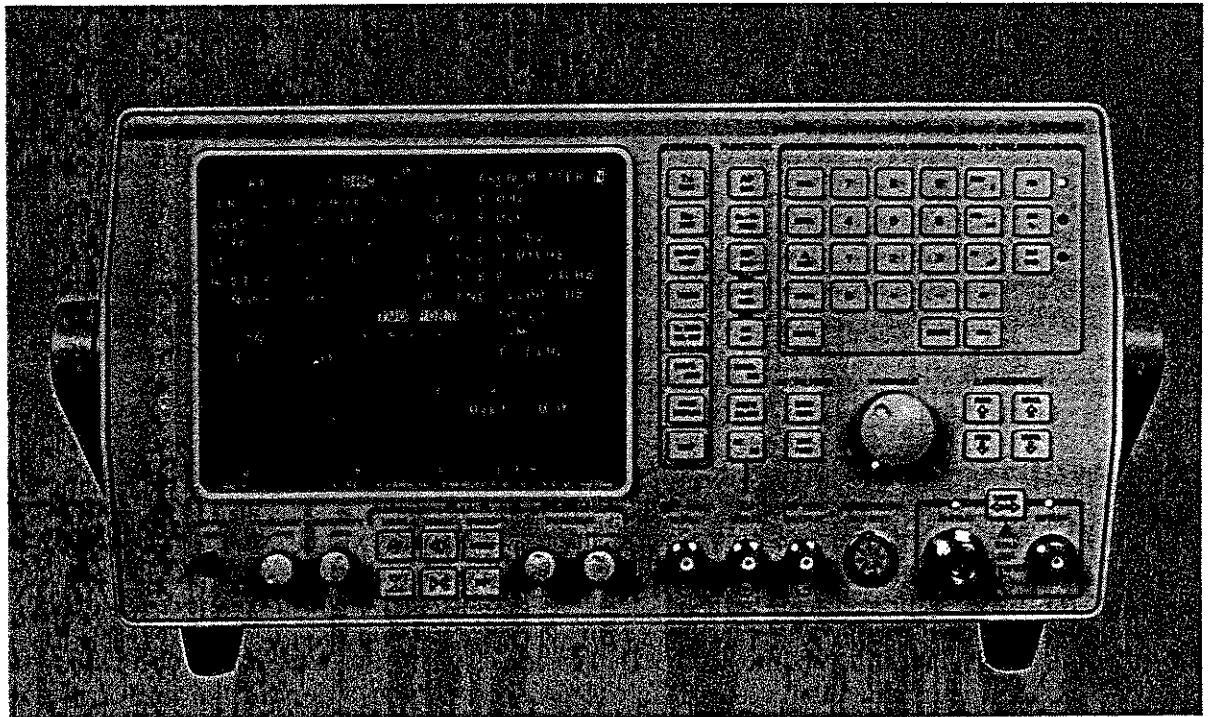

Fig. 1-1 Radio Communications Test Set 2955B

GENERAL INFORMATION

Push-button selection makes all the necessary interconnections for each measurement, eliminating the need for the many interconnections required when separate instruments are used. Function selection and data entries are made on a colour-coded keyboard with the operating sequence logically arranged from left to right. Instrument operation is greatly facilitated by means of CRT displays which provide prompts during data entry and guidance during operating sequences while also showing the instrument settings and the measurement results. The measurement results are displayed by digital readouts and also by either autoranging bar charts or by a storage oscilloscope which has repetitive sweep, single shot and freeze facilities.

Frequency meters. As there are two frequency counters, simultaneous AF and RF frequency readings can be displayed. Ranges and resolutions are respectively from 20 Hz to 20 kHz at 0.1 or 1 Hz and from 1.5 to 1000 MHz at 1 or 10 Hz. Either an internal or an external frequency standard can be used.

Signal generator. The signal generator can be amplitude, frequency, or phase modulated, internally or externally, the internal modulating signal being obtained from the AF generators. Amplitude modulation is variable up to 99% for carrier frequencies from 0.4 to 500 MHz. FM deviation can be set from 0 to 25 kHz and Φ M deviation from 0 to 10 radians. Transmitter and receiver RF signals use N and BNC connectors which are selected by means of a key. Reverse power overload is indicated by a visual warning and an audible alarm. When a reverse power overload is applied to the BNC socket, an automatic trip circuit operates.

Modulation meter. Automatic frequency tuning and levelling of the modulation monitor provide accurate measurements of AM, FM and Φ M. Because of the independent tuning, modulation measurements can be made on duplex systems. The modulation can be observed on an oscilloscope and its symmetry checked from the peak and trough values displayed on a dual bar chart. The demodulated output is available at a rear panel socket. Provision is made for audible monitoring using the built-in loudspeaker or by an external loudspeaker or headphones.

RF power meter. The absorption RF power meter measures up to 75 W continuously or up to 150 W for short periods over a frequency range of 1.5 to 1000 MHz. The connection of the RF Directional Power Head (available as an optional accessory) extends the capability of the instrument by enabling measurements of forward power, reverse power and VSWR to be made.

AF generators. The two AF generators provide a range of frequencies from 10 Hz to 20 kHz for single-tone or two-tone testing. The audio output is available at a front panel socket and the generators also provide the internal AM, FM and Φ M for the RF signal generator. A combined 600 Ω Balanced to Unbalanced Converter and 20 dB Attenuator is available as an optional accessory.

AF voltmeter. Operating in the range 20 Hz to 20 kHz, the true RMS voltmeter has provisions for measuring AF or AF plus the DC component. Band-pass and low-pass filters can be selected.

Distortion, S/N (signal to noise) or SINAD (signal to noise and distortion) meter. The AF distortion meter operates at 1 kHz which is supplied by one of the AF generators. The bar chart displays are autoranged at 10% and 30% (for distortion), at 30 and 100 dB (for S/N) or at 18 and 50 dB (for SINAD). The Psophometric Filter Units (available as optional accessories) enable CCITT and C-message weighted measurements to be made.

Sequential tones decoder and encoder. For testing selective calling tones encoding and decoding equipment, the instrument is capable of receiving and generating five defined tone frequency standards plus a user-defined standard. Provision is made to receive and to send sequences of up to 33 tone frequencies. For transmitter testing, each received tone is compared with the standard frequency allocations which is held in memory and, if it is within the limits, its tone number and % frequency error are displayed. For receiver testing, the tones can be generated in single step, tone burst or continuous cycle. There is a revertive tones facility whereby tones are sent to a receiver and the the answering sequence is decoded.

DTMF decoder and encoder. There are similar facilities for testing DTMF encoding and decoding equipment.

DCS decoder and encoder. There are similar facilities for DCS encoding and decoding equipment.

POCSAG radio pager encoder. The instrument can be used to check the response of a pager to an RF signal modulated with the pager's address and an appropriate message. Deliberate errors can be created in the outgoing signal.

GPIB Interface Unit. This unit allows the instrument to form part of an automatic test system. Displays can be configured to the user's own requirements using a comprehensive character set. With this unit, a 24 Column Printer (available as an optional accessory) can be used.

Serial Interface Unit. This unit allows the instrument to be controlled by a personal computer using the EIA-232 (formerly RS-232) standard. Displays can be configured to the user's own requirements using a comprehensive character set.

Off-air receiver. In the Option 1 only, there is a sensitive receiver which allows off-air monitoring of transmitters.

Calibration and testing. Routine calibration has been kept to a minimum. Calibration factors are stored in a non-volatile memory and can be accessed with a secure access code from the front panel keys or by the GPIB, permitting rapid recalibration. A built-in self test facility can be called up whenever it is required. This enables faults to be identified to major module level or to groups of components.

Special features

TRANSMITTER TESTING

Setting:	Press TX TEST key to select this test mode.
Auto-tuning:	Typically under 3 seconds to acquire and measure RF frequency, RF power, modulation frequency and level and modulation distortion.
Manual tune:	Displays positive and negative frequency offset from carrier. 3 digits and decimal point indicate most significant error.
Sequential tones:	Decodes CCIR, ZVEI, DZVEI, EEA or EIA and user-defined menu. Provides tone number, frequency and % error for up to 33 tones. Tone deviation and duration can be monitored using the digital storage oscilloscope in the transmitter test mode.
RX=TX key:	Presets the RF signal generator frequency for the receiver test mode to that shown in the transmitter test mode.
HOLD DISPLAY key:	Freezes screen settings and readings facilitating high RF power measurements and hard copy printout of the TRANSMITTER TEST, RECEIVER TEST, DUPLEX test or AUDIO TEST displays.

RECEIVER TESTING

Setting:	Press RX TEST key to select this test mode. Default settings of RF level, modulation frequency and level reduce function test time.
Signal generator:	Output level accuracy ± 2 dB over entire frequency, temperature and attenuator ranges. Level units keyboard selectable either dBm, dB μ V or μ V. Software menu allows user to switch between PD and EMF levels.
Distortion and noise meter:	User-settable default condition allows either S/N or SINAD readings, a dedicated key is provided to toggle the setting.
Sequential tones:	Encodes CCIR, ZVEI, DZVEI, EEA or EIA and user-defined frequencies. User can send up to 33 tones in any standard continuously, by tone step or in a burst. A facility allows for tones to be extended.

DUPLEX TESTING

Setting:

Press DUPLEX TEST key to select this test mode.

Modulation meter:

Independent modulation meter and RF signal generator allows any frequency offset for duplex radio or cross-band repeater testing.

Sequential tones:

Decodes and encodes CCIR, ZVEI, DZVEI, EEA or EIA and user-defined menu. User can send up to 33 tones in any standard continuously, by tone step or in a burst. A facility allows for tones to be extended.

Performance data

RF SIGNAL GENERATOR

Output impedance	50 Ω nominal.
VSWR:	N socket; <1.2:1 to 500 MHz. <1.3:1 to 1000 MHz. BNC socket; <2.2:1 to 1000 MHz.
Frequency	
Range:	0.4 to 1000 MHz (usable to 1060 MHz).
Resolution:	50 Hz up to 530 MHz. 100 Hz up to 1000 MHz.
Indication:	8 digit display.
Setting:	Keyboard entry; step change variation by increment/decrement keys and rotary control.
Accuracy:	As internal standard.
Output level	
Range	
N socket:	-135 to -15 dBm (0.04 μ V to 40 mV).
BNC socket:	-115 to +5 dBm (0.4 μ V to 400 mV).
One-port duplex:	-140 to -21.5 dBm (0.0224 μ V to 18.85 mV).
Two-port duplex:	-115 to -15 dBm (0.4 μ V to 40 mV).
Resolution:	0.1 dB.
Indication:	4 digits (dBm/ μ V, PD/EMF and dB μ V).
Accuracy:	\pm 1.8 dB for levels above -127 dBm over temperature range 18 to 28°C.
Spectral purity	
FM on CW:	<13 Hz RMS up to 500 MHz. <26 Hz RMS up to 1000 MHz. (0.3 to 3.4 kHz bandwidth). Typically 8 Hz up to 250 MHz, 10 Hz up to 500 MHz, 20 Hz up to 1000 MHz.
Harmonics:	Harmonics specified in band 0.4 to 1000 MHz only. <-20 dBc up to 1.5 MHz. <-25 dBc 1.5 MHz to 250 MHz. <-20 dBc 250 MHz to 1000 MHz.
Sub-harmonics:	None up to 530 MHz, <-25 dBc up to 1000 MHz.

Spurious signals: Carrier up to 88 MHz—
 <-45 dBc below 110 MHz.
 <-35 dBc above 110 MHz.
 Carrier up to 1000 MHz <-60 dBc.

S/N at 20 kHz: <-110 dBc/Hz to 500 MHz.
 <-104 dBc/Hz to 1000 MHz.

RF carrier leakage: <0.2 μ V PD generated in a 50 Ω load by a 2-turn 25 mm loop as near as 25 mm to the case of the instrument with the output set to less than -40 dBm and the output terminated in a 50 Ω sealed load.

Protection: N socket; Reverse power overload is indicated by a visual warning (REMOVE RF INPUT) and an audible alarm.
 BNC socket; Reverse power protection up to 50 W, automatically resets on removal of power input. Tripping is indicated by visual warning (REMOVE RF INPUT) and an audible alarm.

CW on/off key: Switches RF output on and off.

MODULATION GENERATOR

Amplitude modulation

CW range: 1.5 to 400 MHz.
 Usable from 400 kHz to 500 MHz.

Modulation range: 0 to 99%.

Frequency range: 20 Hz to 20 kHz.

Resolution: 1%.

Indication: 2 digits.

Setting: Keyboard entry; step change variation by increment/decrement keys and rotary control.

Accuracy: $\pm 7\%$ of setting ± 1 digit at 1 kHz up to 85% AM.
 $\pm 10\%$ of setting ± 1 digit from 50 Hz to 5 kHz only and 0 to 70% AM only.
 $\pm 15\%$ of setting ± 1 digit from 50 Hz to 15 kHz and 0 to 85% AM.

GENERAL INFORMATION

AM external input

Input impedance:	1 M Ω in parallel with 40 pF approximately.
CW range:	1.5 to 400 MHz.
Modulation depth range:	0 to 99%.
Frequency range:	20 Hz to 20 kHz.
Sensitivity:	50 Hz to 5 kHz, up to 70% AM; 1.5 V p-p for 30% AM $\pm 10\%$ $\pm 1\%$ AM. 50 Hz to 15 kHz, up to 85% AM; 1.5 V p-p for 30% AM $\pm 15\%$ $\pm 1\%$ AM.
AM distortion:	<2% distortion at 1 kHz with 30% AM in a 0.3 to 3.4 kHz bandwidth.

Frequency modulation

CW range:	0.4 to 1000 MHz.
Deviation range:	0 to 25 kHz.
Modulation frequency range:	20 Hz to 20 kHz.
Resolution:	25 Hz (<6.25 kHz deviation). 100 Hz (<25 kHz deviation).
Indication:	4 digits.
Setting:	Keyboard entry. Step change variation by increment/decrement keys and rotary control.
Accuracy:	$\pm 7\%$ ± 10 Hz (at 1 kHz), $\pm 10\%$ (50 Hz to 15 kHz).

FM external input

Input impedance:	1 M Ω in parallel with 40 pF approximately.
CW range:	0.4 to 1000 MHz.
Deviation range:	0 to 30 kHz deviation.
Modulation frequency range:	1 Hz to 50 kHz.
Sensitivity:	1 V p-p for 5 kHz deviation $\pm 10\%$.
FM distortion:	<1% distortion at 1 kHz with 5 kHz deviation in a 0.3 to 3.4 kHz bandwidth.

Phase modulation

CW range:	0.4 to 1000 MHz.
Deviation range:	0 to 10 rad.
Modulation frequency range:	0.3 to 3.4 kHz.
Resolution:	0.025 rad steps <6.3 rad, 0.1 rad steps >6.3 rad.

Indication: 3 digits.
 Setting: Keyboard entry. Step change variation by increment/decrement keys and rotary control.
 Accuracy: $\pm 8\%$ at 1 kHz, $\pm 11\%$ from 0.3 to 3.4 kHz.

 Φ M external input

Input impedance: 1 M Ω in parallel with 40 pF approximately.
 CW range: 0.4 to 1000 MHz.
 Deviation range: 0 to 10 rad.
 Frequency range: 0.3 to 3.4 kHz.
 Sensitivity: 1.0 V p-p for 5 rad at $\pm 12\%$ at 1 kHz.
 Φ M distortion: $< 2\%$ at 1 kHz with 5 rads, measured in a 0.3 to 3.4 kHz bandwidth.

AF GENERATORS

Two tone: Two tones are available, separately controllable for frequency, shape and level.

Output impedance: $< 5 \Omega$.

Frequency

Range: 50 Hz to 15 kHz. Usable 10 Hz to 20 kHz.
 Resolution: 0.1 Hz from 10 Hz to 3.25 kHz.
 1 Hz from 3.25 to 20 kHz.
 Indication: 5 digits.
 Setting: Keyboard entry. Step change variation by increment/decrement keys and rotary control.
 Accuracy: ± 0.01 Hz from 10 to 100 Hz.
 ± 0.1 Hz from 100 Hz to 20 kHz.

Shape: Sine, square, triangle and saw-tooth.

Output level (EMF)

Range: 0.1 mV to 4.095 V RMS (sine and square),
 0.1 mV to 4.095 V peak (triangle and saw-tooth).
 Accuracy: $\pm 5\% \pm 1$ step, 50 Hz to 15 kHz.
 Setting: 0.1 mV steps (0.1 to 409.0 mV),
 1 mV steps (409.0 mV to 4.095 V).

GENERAL INFORMATION

Signal purity (sine only)

Distortion:	<0.3% at 1 kHz. <0.6% from 50 Hz to 15 kHz (excluding residual noise).
Residual noise:	<0.1 mV RMS in CCITT psophometric bandwidth.
DC offset:	<10 mV DC.

RF FREQUENCY METER

Frequency

Range:	1.5 to 1000 MHz (usable to 1060 MHz).
Resolution:	1 Hz or 10 Hz up to 200 MHz, 10 Hz only from 200 to 1000 MHz.
Accuracy:	As internal standard ± 1 digit.

Input

Impedance:	50 Ω nominal.
VSWR:	N socket; <1.2:1 to 500 MHz, <1.3:1 to 1000 MHz. Typically <1.2:1 to 1 GHz. BNC socket; <2.2:1 to 1000 MHz.
Sensitivity:	N socket; 5 mW, transmitter test mode selected. In one-port duplex mode, sensitivity reduces to 20 mW. BNC socket; 50 mV usable.
Update rate:	100 ms for frequencies up to 200 MHz with 10 Hz resolution selected, 400 ms for frequencies up to 1000 MHz, 10 Hz resolution only.

RF POWER METER

Input

Impedance:	As RF frequency meter.
VSWR:	As RF frequency meter.
Ranges:	N socket; Transmitter test mode 50 mW to 150 W. Usable down to 5 mW. One-port duplex mode 100 mW to 150 W. Usable down to 20 mW. Two-port duplex mode 50 mW to 100 W. Usable down to 5 mW. BNC socket; 0.05 to 250 mW.

Continuous rating:	75 W at 0 to 50°C.
Maximum input:	N socket; Transmitter test mode, 150 W. One-port duplex mode, 150 W. Two-port duplex mode, 100 W. For limited period, typically 2 minutes at 25°C. End of usable working period is indicated by a visual warning (REMOVE RF INPUT) and an audible alarm. BNC socket; Overload protection up to 50 W. Tripping is indicated by a visual warning (REMOVE RF INPUT) and an audible alarm.
Frequency range:	1.5 to 1000 MHz.
Resolution:	1% of indicated bar chart range.
Indication:	2 or 3 digits and analogue display.
Setting:	Automatic ranging on scales 0 to 30, 0 to 100, 0 to 300 mW; 0 to 1, 0 to 3, 0 to 10, 0 to 30, 0 to 100, 0 to 300 W.
Accuracy:	N socket; $\pm 10\%$ ± 1 digit up to 500 MHz, $\pm 15\%$ ± 1 digit up to 960 MHz, $\pm 20\%$ ± 1 digit up to 1000 MHz. ± 1.25 dB ± 1 digit at 5 to 50 mW over the ranges 825 to 905 MHz from +15 to +25°C. (There may be a difference between a transmitter test mode reading and a duplex test mode reading. The difference is normal and within the above limits.) BNC socket; $\pm 25\%$ nominal.

MODULATION METER

Input

Manual tune:	Provides frequency offset indication from carrier, 3 digits and decimal point. Indicates most significant positive or negative error.
Auto tune:	Provides measurement and simultaneous display of RF frequency, RF power, modulation frequency and level.

GENERAL INFORMATION

Sensitivity: N socket; Transmitter test mode
5 mW (0.5 V).
One-port duplex mode
20 mW (1 V).
BNC socket; 0.05 mW (50 mV).

Acquisition time: <3 s with 10 Hz resolution selected.

AF filters available: Band-pass - 0.3 to 3.4 kHz.
Low-pass - 0.3 or 15 kHz.

External filter route: Demodulated signal from the rear panel socket to the external filter and returned to the AF input socket.

Amplitude modulation

CW range: 1.5 to 400 MHz.

Modulation depth range: 0 to 90% below 100 MHz.
0 to 80% from 100 to 400 MHz.
Usable to 100% when manually tuned.
Automatic ranging (bar chart), 0 to 10, 0 to 30,
0 to 100% depth.

Modulation frequency range: 50 Hz to 10 kHz. Usable 10 Hz to 15 kHz.

Resolution: 1% AM.

Indication: 2 digits and analogue display.

Accuracy: $\pm 5\%$ of reading ± 1 digit at 1 kHz.
 $\pm 8.5\%$ of reading ± 1 digit from 50 Hz to 10 kHz.

Demodulation distortion: At 30% AM and 1 kHz modulation frequency,
0.3 to 3.4 kHz bandwidth;
<2% at 21 MHz carrier and above,
<5% up to 21 MHz carrier.

Residual AM: <1% for inputs in a 0.3 to 3.4 kHz bandwidth
above 10 mW (N socket) or 0.1 mW (BNC socket).

Frequency modulation

CW range: 1.5 to 1000 MHz.

Deviation range: 0 to 25 kHz.
Automatic ranging (bar chart), 0 to 1, 0 to 3,
0 to 10, 0 to 30 kHz.

Modulation frequency range: 50 Hz to 10 kHz. Usable 10 Hz to 15 kHz.

Resolution: 10 Hz up to 2.5 kHz deviation.
1% up to 25 kHz deviation.

Indication:	3 digits and analogue display.
Accuracy:	$\pm 5\% \pm 1$ digit at 1 kHz. $\pm 7.5\% \pm 1$ digit over range 50 Hz to 10 kHz.
Demodulation distortion:	<1.5% distortion at 5 kHz deviation and 1 kHz modulation frequency in a 0.3 to 3.4 kHz bandwidth.
Residual FM:	<15 Hz (typically 12 Hz) RMS up to 500 MHz, <30 Hz (typically 24 Hz) RMS up to 1000 MHz for inputs in a 0.3 to 3.4 kHz bandwidth above 20 mW (N socket) or 0.2 mW (BNC socket).

Phase modulation

CW range:	1.5 to 1000 MHz.
Deviation range:	0 to 10 rad. Automatic ranging (bar chart), 0 to 1, 0 to 3, 0 to 10 rad.
Modulation frequency range:	0.3 to 3.4 kHz. Phase demodulation obtained using 750 μ s de-emphasis.
Resolution:	1% or 0.01 rad.
Indication:	3 digits and analogue display.
Accuracy:	$\pm 5\% \pm 1$ digit at 1 kHz, $\pm 7.5\% \pm 1$ digit from 0.3 to 3.4 kHz with respect to 750 μ s de-emphasis.

DISTORTION AND NOISE METER**Distortion**

Frequency:	1 kHz.
Range:	0 to 10%, 0 to 30% distortion.
Resolution:	0.1% distortion.
Indication:	3 digits and analogue display.
Accuracy:	$\pm 5\%$ of reading $\pm 0.5\%$ distortion.
Sensitivity:	50 mV (100 mV for 1% distortion).

S/N

Range:	0 to 30 dB, 0 to 100 dB.
Resolution:	0.1 dB.
Indication:	3 digits and analogue display.
Accuracy:	± 1 dB.
Sensitivity:	50 mV (100 mV for 40 dB S/N).

GENERAL INFORMATION

SINAD

Frequency:	1 kHz.
Range:	0 to 18 dB, 0 to 50 dB.
Resolution:	0.1 dB.
Indication:	3 digits and analogue display.
Accuracy:	± 1 dB.
Sensitivity:	50 mV (100 mV for 40 dB SINAD).

AF FREQUENCY METER

General

Range:	20 Hz to 20 kHz.
Resolution:	0.1 Hz or 1 Hz.
Indication:	3, 4 or 5 digits.
Accuracy:	As internal standard ± 1 digit, ± 0.1 Hz or 0.02% (whichever is greater).
Sensitivity:	50 mV.

AF VOLTMETER

General

Input impedance:	1 M Ω in parallel with 40 pF approximately.
Frequency range:	50 Hz to 20 kHz (or DC). Usable 20 Hz to 50 kHz.
Level range:	0 to 100, 0 to 300 mV; 0 to 1, 0 to 3, 0 to 10, 0 to 30, 0 to 100 V.
Resolution:	1 mV or 1% (dependent on range).
Indication:	3 digits and analogue display.
Accuracy:	$\pm 3\%$ of reading ± 3 mV ± 1 digit.
Frequency response:	Switchable; band-pass 0.3 to 3.4 kHz, low-pass 300 Hz or 50 kHz.

Indication:	3 digits and analogue display.
Accuracy:	$\pm 5\% \pm 1$ digit at 1 kHz. $\pm 7.5\% \pm 1$ digit over range 50 Hz to 10 kHz.
Demodulation distortion:	<1.5% distortion at 5 kHz deviation and 1 kHz modulation frequency in a 0.3 to 3.4 kHz bandwidth.
Residual FM:	<15 Hz (typically 12 Hz) RMS up to 500 MHz, <30 Hz (typically 24 Hz) RMS up to 1000 MHz for inputs in a 0.3 to 3.4 kHz bandwidth above 20 mW (N socket) or 0.2 mW (BNC socket).

Phase modulation

CW range:	1.5 to 1000 MHz.
Deviation range:	0 to 10 rad. Automatic ranging (bar chart), 0 to 1, 0 to 3, 0 to 10 rad.
Modulation frequency range:	0.3 to 3.4 kHz. Phase demodulation obtained using 750 μ s de-emphasis.
Resolution:	1% or 0.01 rad.
Indication:	3 digits and analogue display.
Accuracy:	$\pm 5\% \pm 1$ digit at 1 kHz, $\pm 7.5\% \pm 1$ digit from 0.3 to 3.4 kHz with respect to 750 μ s de-emphasis.

DISTORTION AND NOISE METER**Distortion**

Frequency:	1 kHz.
Range:	0 to 10%, 0 to 30% distortion.
Resolution:	0.1% distortion.
Indication:	3 digits and analogue display.
Accuracy:	$\pm 5\%$ of reading $\pm 0.5\%$ distortion.
Sensitivity:	50 mV (100 mV for 1% distortion).

S/N

Range:	0 to 30 dB, 0 to 100 dB.
Resolution:	0.1 dB.
Indication:	3 digits and analogue display.
Accuracy:	± 1 dB.
Sensitivity:	50 mV (100 mV for 40 dB S/N).

GENERAL INFORMATION

SINAD

Frequency:	1 kHz.
Range:	0 to 18 dB, 0 to 50 dB.
Resolution:	0.1 dB.
Indication:	3 digits and analogue display.
Accuracy:	± 1 dB.
Sensitivity:	50 mV (100 mV for 40 dB SINAD).

AF FREQUENCY METER

General

Range:	20 Hz to 20 kHz.
Resolution:	0.1 Hz or 1 Hz.
Indication:	3, 4 or 5 digits.
Accuracy:	As internal standard ± 1 digit, ± 0.1 Hz or 0.02% (whichever is greater).
Sensitivity:	50 mV.

AF VOLTMETER

General

Input impedance:	1 M Ω in parallel with 40 pF approximately.
Frequency range:	50 Hz to 20 kHz (or DC). Usable 20 Hz to 50 kHz.
Level range:	0 to 100, 0 to 300 mV; 0 to 1, 0 to 3, 0 to 10, 0 to 30, 0 to 100 V.
Resolution:	1 mV or 1% (dependent on range).
Indication:	3 digits and analogue display.
Accuracy:	$\pm 3\%$ of reading ± 3 mV ± 1 digit.
Frequency response:	Switchable; band-pass 0.3 to 3.4 kHz, low-pass 300 Hz or 50 kHz.

INTERNAL FREQUENCY STANDARD

Oven-controlled crystal oscillator

Nominal frequency:	10 MHz.
Temperature coefficient:	< ± 5 parts in 10^8 from 5 to 55°C, < ± 5 parts in 10^9 from 55 to 70°C.
Ageing rate:	< ± 5 parts in 10^8 per month, ± 2 parts in 10^7 per year after 1 month's continuous use.
Warm-up time:	Output frequency is within 2 parts in 10^7 of the final frequency within 10 minutes of being switched on.
Short-term stability:	< ± 1 part in 10^{10} RMS frequency error over a 1 s period.
Retrace error:	<2 parts in 10^7 over 24 hours, at constant temperature and after 30 minutes warm-up.

DIGITAL STORAGE OSCILLOSCOPE

General

Single or repetitive sweep. Available in transmitter test, receiver test and audio test modes and in transmitter monitor mode (Option 1 only).

Calibrated for AM, FM and Φ M.

For viewing demodulated audio (plus external input option).

Frequency range:	DC to 50 kHz. From 3 Hz on AC.
Voltage range:	10 mV/div to 20 V/div in 1-2-5 sequence.
Accuracy:	$\pm 5\%$.
FM ranges:	$\pm 30, 15, 6, 1.5$ kHz deviation at $\pm 10\%$ accuracy.
AM ranges:	20, 10, 5%/div at $\pm 10\%$ accuracy.
Φ M ranges:	$\pm 15, 7.5, 3, 1.5$ rad at $\pm 10\%$ accuracy.
Sweep rates:	100 μ s/div to 5 s/div in 1-2-5 sequence. Accuracy locked to internal standard.
Trigger:	Repetitive or single shot storage.

SELCALL (SEQUENTIAL TONES) ENCODER AND DECODER

General

	Encodes up to 33 and decodes up to 33 tones in a CCIR, ZVEI, DZVEI, EEA, EIA or user-defined tone sequence.
Tone encoding facilities:	Sends continuous, burst, single step, extend any tone, null, repeat or frequency shift up to $\pm 9\%$ in 1% steps.
Tone decoding facilities:	Displays tone number, frequency and percentage error. Screen indicates null tones (using CRT) and annotates out-of-limit frequencies.
User-defined tones:	Allows definition for encoding or decoding of up to 15 tones. Frequency ranges are 20 Hz to 20 kHz (encode) and 300 Hz to 3.4 kHz (decode) with duration ranges of 10 to 999 ms (encode) and 20 ms to 1.2 s (decode). Up to a maximum of 33 tones can be sent at any one time. The frequencies are retained in a non-volatile memory.
Capability in audio test mode:	The tones encode and decode facility is available using AF generator output and the AF input BNC sockets.
Revertive tones:	Available in receiver test mode. Set of tones is sent and the instrument awaits a response from the unit under test.

ADDITIONAL FEATURES

Demodulation output socket

Level:	Approximately 400 mV p-p for ± 1 kHz deviation.
Impedance:	10 k Ω nominal.
Bandwidth:	0.3 to 3.4 kHz band-pass, 300 Hz low-pass or 15 kHz low-pass selected by front panel filter switch.

Accessory socket:

Pin 2, +12 V, 100 mA maximum.
Pin 7, AF output, 1 W into 8 Ω .
Pin 1, pulse output available under GPIB control, approximately 600 ns.
Pins 3, 4, 5, 6, accessory control.

DTMF encoder and decoder:

Provides DTMF encoding and decoding under a tones menu. Tone duration and inter-tone gaps can be set at 10 to 999 ms in 1 ms steps.

- Pager testing:** Encoding of POCSAG code CCIR No.1 Rec. 584.
 Bit rate 400 to 1500 bit/s.
 Deviation setting 0 to 25 kHz.
 Allows entry of the following:-
 Radio identity code (RIC),
 4 addresses,
 2 preset numeric messages,
 4 alphanumeric messages,
 Insertion of bit errors.
 RF frequency is 153.125 MHz for Europe,
 152.24 MHz for USA.
 A data invert facility is provided.
- DCS encoding:** Digitally coded squelch.
 Allows entry of the following:-
 Bit rate 100 to 200 bit/s,
 Deviation setting 0 to 25 kHz,
 Polarity normal or inverted,
 3-digit code.
- DCS decoding:** Measures bit rate and deviation. All possible codes and polarity are displayed.
- External modulation measurement:** Accessed by means of a receiver modulation setup menu. The instrument can be configured to measure the modulation generated by a signal connected to the external modulation input socket. By adjusting the applied signal level, the required modulation level can be set.
- Special key functions**
- RX=TX FREQ:** Presets the RF signal generator frequency for receiver test mode to that shown in the transmission test mode.
- HOLD DISPLAY:** Freezes instrument settings and readings, facilitating high RF power measurements and hard copy printout of transmitter, receiver, duplex or audio test displays.
- INCREMENT:** Available in transmitter, receiver, duplex and audio test modes for defining frequency and level increments and decrements of the AF and RF signal generators. The step size can be any setting within the range and resolution of the test set.
- STORE and RECALL:** 26 non-volatile stores, 01 to 26, are provided. Each is capable of retaining all front panel settings for up to 10 years. An additional store, 00, is provided to retain the last test set-up in the event of a power failure. Store 26 is used by a Cellular Adaptor for set-up information.

GENERAL INFORMATION

ON OFF (with SET MOD,
AF GEN LEVEL or
RF GEN LEVEL):

Turn relevant functions on and off.

Hold range on bar chart:

Each displayed bar chart can be held (i.e. no autoranging) by the use of the oscilloscope keys.

HELP key:

Provides access to self test, stores lock, RF frequency meter resolution, default settings for SINAD or S/N, external attenuator offset, variable default deviation, 2955 emulation, default AF filter, RX/TX modulation type lock, European or USA tones standard selection and user instruction guide for transmitter, receiver, duplex and audio test modes.

Miscellaneous

Audible output:

For listening to demodulated output and received audio.

Two tone modulation:

In transmitter test mode, two tones are available under a tones menu. In receiver test mode, external modulation inputs add to the internal modulation.

Transmitter distortion:

In duplex test mode, transmitter distortion measurement is possible.

Transmitter S/N and SINAD:

In transmitter test mode, S/N and SINAD measurement is possible.

Transmitter audio response:

Relative modulation level measurements in transmitter test mode are possible. (Units are dBr.)

Remote control:

All functions except the supply switch and analogue controls are remotely programmable through the GPIB interface unit.

GPIB:

Complies with the following subsets as defined in IEEE 488-1978:- SH1, AH1, T5, L4, SR1, RL1, PPO, DC1, DT1, E1.

OFF-AIR RECEIVER (OPTION 1 ONLY)**General**

Frequency range:	100 kHz to 1000 MHz. Usable to 1060 MHz.
Sensitivity:	2 μ V for 10 dB SINAD in 12 kHz bandwidth, from 1 to 1000 MHz for 3.5 kHz deviation in psophometric bandwidth (typically 1 μ V).
Linearity response:	Typically ± 3 dB level accuracy at 100 MHz with reference to -60 dBm over the range -87 to -24 dBm (10 μ V to 14 mV) at the BNC socket or -67 to -4 dBm (100 μ V to 140 mV) at the N socket.
Level response:	Typically ± 3 dB over frequency range 10 to 1000 MHz.
Indicated signal strength range:	1 μ V to 30 mV into BNC socket. 10 μ V to 300 mV into N socket.
Image response:	0 dB at ± 42.8 MHz of RF input.
Damage level in Tx monitor mode:	>1 W into BNC socket. >75 W into N socket.
Squelch:	A squelch control is provided so that the squelch threshold level can be adjusted.

GENERAL**AC power requirements**

Rated supply voltage:	105 to 120 V AC $\pm 10\%$. 210 to 240 V AC $\pm 10\%$.
Supply frequency range:	45 to 440 Hz.
Maximum consumption:	100 VA.

DC power requirements (Option 6 only)

Supply voltage:	11 to 32 V DC.
Supply consumption:	<60 W.

Radio frequency interference:	Conforms with the requirements of EEC Directive 76/889 as to limits of RF interference. Conforms with VDE (Verband Deutscher Elektrotechniker) requirements Vfg 1046/1984 Class B. (See self-certificate on p. viii.)
-------------------------------	---

GENERAL INFORMATION

Safety: Complies with IEC 348.

Environmental

Rated range of use: 0 to 50°C.

Limit range of operation : 0 to 55°C.

Conditions of storage and transport

Temperature: -40 to +70°C.

Humidity: Up to 90% humidity.

Altitude: Up to 2500 m (pressurized freight at 27 kPa differential (i.e. 3.9 lbf/in²).

Dimensions and weight

Basic unit

Height: 175 mm (6.9 in).

Width: 345 mm (13.6 in).

Depth: 460 mm (18.1 in).

Including handle, feet and cover

Height: 197 mm (7.8 in).

Width: 389 mm (15.3 in).

Depth: 584 mm (23.0 in).

Weight: 15.5 kg (34 lb).

Accessories

SUPPLIED

	Part no.
Operating Manual	46882-113R
Introductory Guide	46882-115K
Operating Summary Card	46882-116A
AC Supply Lead	43129-003W
DC Supply Lead (Option 6 only)	43130-119U
Telescopic Antenna, BNC (Option 1 only)	54421-001N

OPTIONAL

Service Manual	46882-114B
GPIB Interface Unit	54433-002Y
Serial Interface Unit	54433-004L
Multi-system Cellular and Trunked Adapter to convert 2955B, with GPIB Interface Unit fitted, to 2960B (one, two, three or four Option Kits required consisting of ROM IC, Front Panel Label, Operating and Programming Manual Supplements)	54415-015G
NMT Cellular Option Kit for 2960	46884-101J
AMPS Cellular Option Kit for 2960	46884-102F
TACS Cellular Option Kit for 2960	46884-103G
Band III Trunked Option Kit for 2960	46884-105S
AMPS Cellular Adapter to convert 2955B, with GPIB Interface Unit fitted, to 2957B	54415-018W
Custom Test Software Package (PATSIIE) for 2960	44991-064D
Front Stowage Cover	41690-411S
Rack Mounting Kit	54127-309Z
Lead Assembly, BNC connectors, 1.5 m	43126-012S
Lead Assembly, N connectors, 1.0 m	54311-095C
Lead Assembly, DIN 7-way connectors, 1.0 m	43130-590R
Lead Assembly, DIN 7-way connectors, 3.0 m	43130-591B
Lead Assembly, BNC connectors, 1.0 (double screened for enhanced RFI performance)	43137-052Y
GPIB Adapter, IEEE male to IEC female	46883-408K
GPIB Lead Assembly, IEEE connectors, 1.0 m	43129-189U
GPIB Lead Assembly, IEEE connectors, 1.0 m (double screened for enhanced RFI performance)	46883-962H
Dual DIN Connector Assembly	44990-814K
Telescopic Antenna, BNC (except Option 1)	54421-001N
Viewing Hood Assembly	54150-022P
Extender Card	46883-725U
Transit Case	46662-192W
Soft Carrying Case	46662-432V
Psophometric Filter Unit (CCITT weighted)	54499-042L
Psophometric Filter Unit (C-message weighted)	54499-043J
600 Ω Interface Unit	
(Balanced to Unbalanced Converter and 20 dB Attenuator)	54411-052M
24 Column Printer	54211-001D
Printer Ribbon and Paper Kit	46883-877P

GENERAL INFORMATION

Battery Pack (with charger)	54462-023W
IF Probe 455 kHz	54451-165L
IF Probe 470 kHz	54451-163Y
IF Probe 10.7 MHz	54451-164N
20 dB AF Attenuator	54431-023A
RF Directional Power Head, 1 to 50 MHz	54421-002L
RF Directional Power Head, 25 to 1000 MHz	54421-003J
Wide Band Amplifier Unit	54432-012H
150 Hz Bandstop Filter Unit	54491-325H
Impedance Matching Unit	54411-053C
Microphone Interface Unit	54432-013E
Microphone	54412-020Y

Chapter 2

INSTALLATION

	Page
UNPACKING AND REPACKING	2-1
GPIB AND SERIAL INTERFACE UNITS	2-2
MOUNTING ARRANGEMENTS	2-3
RACK MOUNTING	2-3
BATTERY PACK	2-3
SAFETY TESTING	2-4
POWER REQUIREMENTS	2-4
AC power supply	2-4
DC power supply	2-5
AC and DC operation	2-5
ACCEPTANCE TESTING	2-5
CONNECTIONS	2-6
GPIB cable	2-6
GPIB connectors	2-6
Serial interface connectors	2-7
ACCESSORY IN/OUT socket	2-7
RF IN/OUT socket	2-8

UNPACKING AND REPACKING

Retain the container, packing material and the packing instruction note (if included) in case it is necessary to reshipe the instrument.

If the instrument is to be returned for servicing, attach a label indicating the service required, type or model number (on rear label), serial number and your return address. Pack the instrument in accordance with the more detailed information which is given in the packing instruction note or as follows:-

- (1) Place the mains lead in a suitable plastic bag and tape it to the instrument's rear panel.
- (2) Place the instrument within its plastic cover.
- (3) Ensure that the padded fitting is in place within the inner carton and slide the instrument in, rear panel first, leaving the front panel exposed at the open end.
- (4) Fit the separate front panel protecting cover over the panel and close and seal the inner carton.
- (5) Place one of the moulded plastic cushions in the bottom of the outer carton and insert the inner carton so that it locates in the cushion recess.
- (6) Place the remaining plastic cushion over the other end of the inner carton and close and seal the outer carton.
- (7) Wrap the container in waterproof paper and secure it with adhesive tape.
- (8) Mark the package FRAGILE to encourage careful handling.

Note...

If the original container or materials are not available, use a strong double-wall carton packed with a 7 to 10 cm layer of shock absorbing material around all sides of the instrument to hold it firmly. Protect the front panel controls with a plywood or cardboard load spreader.

GPIB AND SERIAL INTERFACE UNITS

The GPIB Interface Unit is fitted except under Option 2. It is available as an optional accessory (part no. 54433-002Y).

The Serial Interface Unit is fitted under Option 3. It is available as an optional accessory (part no. 54433-004L).

Install either of the Units in the 2955B as follows:-

- (1) Remove the 2955B's AC Supply Lead.
- (2) On the 2955B, remove the top cover by unscrewing the four retaining screws.
- (3) If another Interface Unit is already fitted, remove it by unscrewing the two mounting screws and unplugging the ribbon cable from the motherboard.
- (4) If another Interface Unit is not already fitted, remove the small cover from the top right-hand corner of the rear panel by unscrewing its mounting screws.
- (5) Withdraw the new Interface Unit from its packaging, offer it up to the hole in the top right-hand corner of the rear panel and insert the two mounting screws.
- (6) On the 2955B's motherboard, observing the CAUTION instructions below, connect the Interface Unit's ribbon cable to the connector which is marked PLC and GPIB INTERFACE.

CAUTION - CONNECTOR POSITION

Ensure that PLC is used. Do not use the connector which is marked PLZ and RECEIVER INTERFACE. Otherwise, damage can occur.

CAUTION - CONNECTOR ORIENTATION

Ensure that the red strip at the edge of the ribbon cable is on the side away from the Interface Unit with the cable coming out away from the CRT. Otherwise, damage can occur.

- (7) Replace the top cover and the four retaining screws.
- (8) Insert the AC Supply Lead and switch on the instrument. ADR normally appear (except in the talk only mode) in reverse video in the bottom right-hand corner of the screen.
- (9) Use a suitable lead between the Interface Unit and your computer's output connector. For the GPIB Interface Unit, see under 'GPIB lead connection'. For the Serial Interface Unit, two types of lead are available as optional accessories for the majority of computers which use 25-way or 9-way D connectors.
- (10) For the Serial Interface Unit, run the CHECK program on your computer (MS-DOS version 3 or higher) using one of the Verification Discs which are supplied as accessories. Follow the instructions which are given on the screen. If there is no response, check the installation.

MOUNTING ARRANGEMENTS

Excessive temperature may affect the instrument's performance. Therefore, completely remove the plastic cover, if one is supplied over the case, and avoid standing the instrument on or close to other equipment that is hot.

RACK MOUNTING

The instrument can be mounted in a 19 inch rack by using the Rack Mounting Kit (part no. 54127-309Z) which is available as an optional accessory. Fit the Rack Mounting Kit as follows:-

- (1) When it is necessary to reduce the height of the instrument, the feet can be removed. This can be carried out without removing the bottom cover. Ease the centre bungs from the feet to expose the retaining screws which are held in captive nuts.
- (2) Remove any Front Cover which can no longer be used.
- (3) From each side of the handle, ease off the grey plastic button.
- (4) From each side of the handle, remove the central screw and withdraw the handle.
- (5) On each side, offer up the appropriate rack bracket and secure it with the M5 screw.

Note...

Ensure that there is adequate ventilation for the blown air cooling system.

BATTERY PACK

The external Battery Pack (part no. 54462-023W), available as an optional accessory, is mounted on top of the instrument as follows:-

- (1) Position the Battery Pack above the instrument and fit the projecting lugs at the rear of the Battery Pack (tilting as necessary) into the slots in the instrument's rear feet.
- (2) Secure the Battery Pack in place by passing the carrying strap around the body of the instrument then pulling the strap through the friction buckle until tight. Hold the remaining strap length in place using the Velcro fastener.
- (3) To release, press the friction bar to unclamp the strap then ease the lugs out of the rear feet.
- (4) Unclip the connector by pressing on its sides to release it from its storage point, and pull out the attached lead from the case. Reclip the connector to the DC SUPPLY socket on the rear panel.

SAFETY TESTING

Where safety tests on the AC supply input circuit are required, the following procedures can be applied. These comply with BS 4743 and IEC Publication 348. To ensure that AC supply input circuit components and wiring (including earthing) are safe under ambient conditions, proceed, in the order given, as follows:-

- (1) Earth lead continuity test from any part of the metal frame to the bared end of the flexible lead for the earth pin of the user's AC supply plug. Preferably a heavy current (about 25 A) should be applied for not more than 5 seconds.

Test limit: not greater than 0.5 Ω .

- (2) 500 V DC insulation test from the AC supply circuit to earth.

Test limit: not less than 2 M Ω .

POWER REQUIREMENTS

The instrument can be operated from AC mains or from an external battery pack.

AC power supply

For AC operation, the instrument requires 105 to 120 V or 210 to 240 V, 50 to 400 Hz, 100 VA.

The required supply fuses (time-lag) are as follows:-

AC power supply	Fuse rating
105 to 120 V	1.6 A
210 to 240 V	0.8 A

Before switching on, ensure that the rear panel voltage range switch is in its correct position as revealed by the cut-out in the locking plate, and that the correct value fuses are fitted. To change the mains voltage setting, reverse the locking plate after setting the slide switch to its alternative position.

The AC Supply Lead is fitted at one end with a female plug which mates with the AC connector at the rear of the instrument. When fitting a supply plug ensure that the connections are as follows:-

Earth (ground) - Green/Yellow
 Neutral - Blue
 Live (phase) - Brown

When attaching the mains lead to a non-soldered plug it is recommended that the tinned ends of the lead are first cut off to avoid the danger of cold flow resulting in intermittent connection.

DC power supply (Option 6 only)

For DC operation, a 16 V 7 Ah rechargeable nickel cadmium Battery Pack is available as an optional accessory. The battery is protected by a time-lag 6.3 A fuse. Remove the battery lead from its stowage and connect to the DC SUPPLY socket on the instrument rear panel. With a fully-charged battery, operating time is in excess of 1 hour.

Alternatively, an external DC supply of between 11 V and 32 V and able to supply approximately 55 W can be used. Connect the battery leads to the rear panel DC SUPPLY socket ensuring that polarities are correct.

AC and DC operation

When both the DC supply and the AC supply are connected, the instrument automatically selects AC power. If the AC power is then removed, the instrument switches to DC with no interruption of operation. In certain circumstances, the external power supply may not be able to take the sudden change in load and the inbuilt protection (e.g. current feedback limiting) switches off the supply. This can normally be prevented by setting the DC supply to around 20 V. No problems should be experienced with units able to supply 32 V at approximately 4 A.

To protect the +12 V power supply to board AC1, an in-line fuse has been fitted between boards AC1 and AB1/1. The fuse is 1.6 A time-lag. Access to it is gained after removal of the upper half of the case. The fuse is located adjacent to the grey box of the crystal oscillator.

ACCEPTANCE TESTING

For inspection testing purposes, carry out the following procedure:-

- (1) Push up the SUPPLY ON switch which is at the bottom left-hand corner of the front panel.
- (2) Check that a display appears on the screen with the words RECEIVER TEST in the heading.
- (3) Initiate the instrument's self testing procedure by first pressing the brown HELP key. A menu appears on the screen with the word HELP in the heading.
- (4) Press the blue SCOPE/BAR key which is alongside the SELF TEST option on the display. A display appears on the screen with the words SELF TEST in the heading.
- (5) Again press the blue SCOPE/BAR key which is now alongside the ALL TESTS option on the display. During each individual test, ACTIVE is displayed. At the end of each of the thirteen individual tests, PASSED should be displayed against each test number. In the case of a failure, FAILED and an error code are displayed against the test number. Further details are given under 'Self testing'.

For detailed performance testing, see Chap. 6.

CONNECTIONS

GPIB cable

Connection to other equipment which has an IEEE 488 24-way connector or an IEC 625 25-way connector can be made with the GPIB Lead Assembly and the GPIB Adapter, available as optional accessories, as shown in Fig. 2-1.

Where conformity with the radio frequency interference limits specified by VDE (Verband Deutscher Electrotechniker) is required, a double-screened Lead Assembly (part no. 46883-962H) is available as an optional accessory.

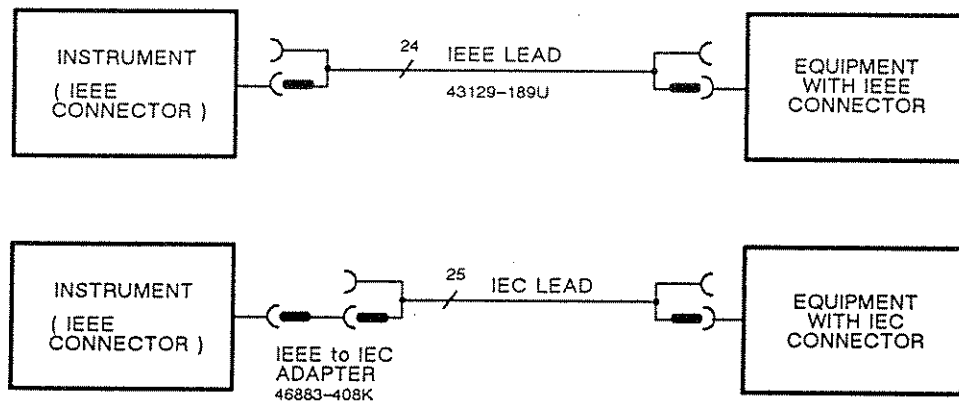

Fig. 2-1 GPIB interconnections

GPIB connectors

The contacts on the GPIB cable connector and the device connector is as shown in Fig. 2-2 below.

The cables have special male-female connectors at both ends. This allows several connectors to be stacked one on top of another permitting several cables to be connected to the same source and secured by a lock screw mechanism. Too large a stack however, may form a cantilevered structure which might cause damage and should be avoided. The piggyback arrangement permits star or linear interconnection between the devices forming a system with the restriction that the total cable length for the system is as follows:-

- (1) No greater than 20 m (65 ft).
- (2) No greater than 2 m (6 ft) times the total number of devices (including the controller) connected to the bus.

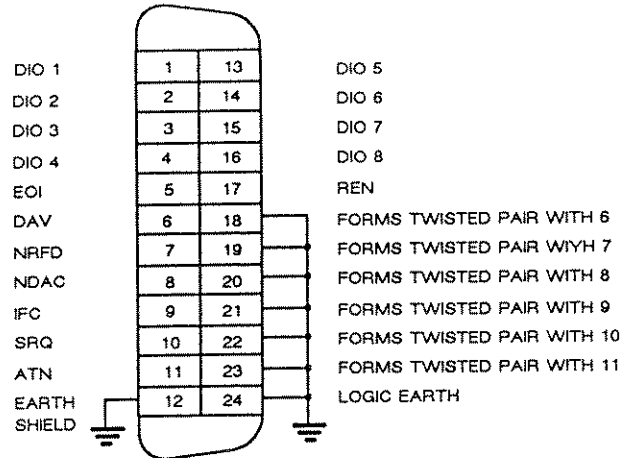

Fig. 2-2 GPIB connector contacts

Serial interface connectors

The Serial Interface Unit has a standard 25-contact connector. To use CTS and RTS flow control with an IBM-compatible computer, pins 2 and 3 are cross connected so that a modem is not necessary. Contacts are as follows:-

Connector contact	IBM contact	Description
2	3	Transmitted Data
3	2	Received Data
4	5 and 6	Request to Send
5	4	Clear to Send
7	7	Signal Common

ACCESSORY IN/OUT socket

The pin numbering of the 7-way DIN socket is shown in Fig. 2-3 as viewed from the front of the instrument. Reading clockwise from the earth shield locating spigot the functions in position order are:-

Position	Pin	Function
1	6	Logic
2	1	Logic
3	4	Forward power
4	2	+12 V DC at approx 100 mA
5	5	Reverse power
6	3	Logic
7	7	Demodulated output

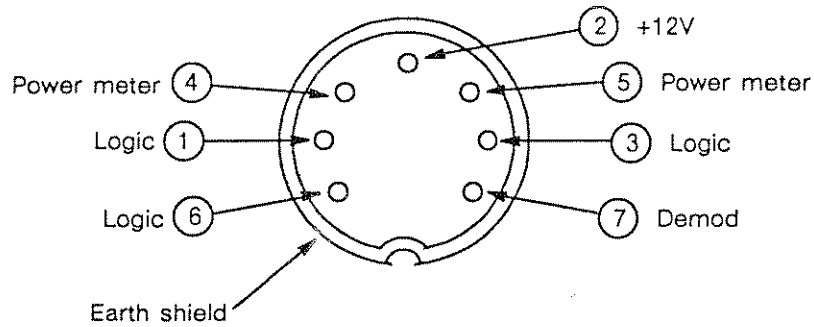

Fig. 2-3 ACCESSORY socket contacts (as viewed from the front)

Selection logic on pins 6, 1 and 3 enable the instrument to detect and recognise the connection of an external accessory. The appropriate pins are at TTL levels and are active low (L) as shown below:

Accessory	Pin 6	Pin 1	Pin 3
Nothing connected	High	High	High
Headset (press to talk)	Low	Low	High
External power: Auto zero	Low	High	Low
External power: Peak power	Low	High	High
External power: CW power	High	High	Low
Psophometric filter: C-message	High	Low	Low
Psophometric filter: CCITT	High	Low	High
Spare	Low	Low	Low

A 3.0 m Lead Assembly (part no. 43130-591B) is available as an optional accessory.

RF IN/OUT socket

Where conformity with the radio frequency interference limits specified by VDE (Verband Deutscher Electrotechniker) is required, a double-screened Lead Assembly (part no. 43137-052Y) is available as an optional accessory.

Chapter 3

LOCAL OPERATION

Introduction to operation

GENERAL...	3-4
INITIAL SETTINGS	3-4
SELF TESTING	3-4
SELECTING THE MEASUREMENT MODE	3-4
FRONT PANEL	3-5
REAR PANEL	3-7
ACCESSORIES	3-8
600 Ω Interface Unit	3-8
Directional Power Heads	3-8
Printer	3-8

Transmitter testing

AF GENERATORS	3-9
AF generator controls and connectors	3-9
AF generator operation	3-10
TONES menu	3-12
Audio setup	3-13
RF POWER METER	3-14
RF power meter controls and connectors	3-14
RF power meter operation	3-15
MODULATION METER	3-16
Modulation meter controls and connectors	3-16
Modulation meter operation	3-17
DISTORTION AND NOISE METER	3-19
Distortion and noise meter controls and connectors	3-19
Distortion and noise meter operation	3-20
APPLICATIONS	3-21
Transmitter frequency adjustment	3-21

Receiver testing

RF GENERATOR	3-22
RF generator controls and connectors	3-22
RF generator operation	3-24
TONES menu	3-27
Modulation setup	3-28
AF VOLTMETER	3-29
AF voltmeter controls and connectors	3-29
AF voltmeter operation	3-30
DISTORTION AND NOISE METER	3-31
Distortion and noise meter controls and connectors	3-31
Distortion and noise meter operation	3-32

Duplex testing

CONTROLS AND CONNECTORS	3-34
OPERATION	3-35
TONES MENU	3-37
MODULATION AND AF SETUP	3-37

Audio testing

AF GENERATORS	3-39
AF generator controls and connectors	3-39
AF generator operation	3-40
TONES menu	3-42
Audio setup	3-43
AF VOLTMETER	3-44
AF voltmeter controls and connectors	3-44
AF voltmeter operation	3-45
DISTORTION METER	3-46
Distortion meter controls and connectors	3-46
Distortion meter operation	3-47

Signalling codes testing

CONTROLS AND CONNECTORS	3-48
SEQUENTIAL TONES OPERATION	3-50
Transmitter testing	3-50
User-defined standard	3-52
Receiver testing	3-53
Duplex testing	3-55
Audio testing	3-55
REVERTIVE SEQUENTIAL TONES OPERATION	3-59
DTMF (DUAL-TONE MULTI-FREQUENCY) OPERATION	3-61
Transmitter testing	3-61
Receiver testing	3-62
Duplex testing	3-64
Audio testing	3-64
DCS (DIGITALLY-CODED SQUELCH) OPERATION	3-64
Transmitter testing	3-64
Receiver testing	3-65
Duplex testing	3-66
POCSAG RADIO PAGER TESTING	3-67

Help key operation

HELP KEY	3-69
OPERATING SUMMARIES	3-69
PARAMETERS	3-71
RF LEVEL selection	3-71
STORE FUNCTION selection	3-71
RF COUNTER RESOLUTION selection	3-72
DEFAULT NOISE READING selection	3-72
600 Ω BALANCED AF ACCESSORY selection	3-72
20 dB ATTENUATOR ACCESSORY selection	3-72
DEFAULT AF FILTER selection	3-72
DEFAULT MOD LEVEL setting	3-72
RX/TX MOD TYPE LOCK selection	3-72
TONE STANDARD selection	3-72
RF LEVEL OFFSET setting	3-73
GPIB MODE selection	3-73
SELF TESTING	3-73

Transmitter monitoring (Option 1 only)

CONTROLS AND CONNECTORS	3-76
OPERATION	3-78
Introduction	3-78
Manual tuning	3-79
Start and step tuning	3-80
Selected frequencies tuning	3-82

Store and recall operation

INTRODUCTION	3-84
STORE PROCEDURE	3-84
RECALL PROCEDURE	3-85

Printer operation

INTRODUCTION	3-86
POWER SUPPLIES	3-86
GPIB CONNECTIONS	3-86
PRINTING	3-86

Introduction to operation

GENERAL

Following power-up conditions and a summary of the front and rear panel controls and connectors, each of the main functions of the instrument is separately detailed in this chapter. The main functions are arranged under the headings of 'Transmitter testing', 'Receiver testing', 'Duplex testing', 'Audio testing' and 'Signalling codes testing'. Additional operating information is provided upon pressing the HELP key, details being given under 'Help key operation'. To familiarize yourself with the instrument, try following the procedures given for 'AF generator operation' in and for 'RF generator operation'.

INITIAL SETTINGS

When switched on, the instrument automatically enters and displays the following set conditions:-

Condition	Setting
Mode	RECEIVER TEST
RF generator frequency	300 MHz
RF generator level	-100 dBm
Modulation frequency	1 kHz
Modulation level	FM 1.5 kHz or user-defined
Filter	0.3 to 3.4 kHz or user-defined
Connector	N socket

SELF TESTING

At any time, following a period after switch-on to allow the frequency standard to stabilize (typically 5 minutes), the instrument can be self-tested. This facility is entered using the HELP key. Operating details are given under 'Help key operation'.

SELECTING THE MEASUREMENT MODE

Once the instrument displays its initial settings, you can select the required measurement, usually in three steps as follows:-

- (1) Select the mode (e.g. Transmitter test, receiver test) - One of the keys with blue marking.
- (2) Select the function (e.g. AF generator, set modulation) - One of the keys with green marking.
- (3) Enter data (e.g. frequency, level) - Keys with brown or grey marking.

Changing from one measurement to another is by simple key operation. For details of the use and operation of the controls for each measurement, see under the relevant heading (e.g. to measure transmitter power, see under 'RF power meter').

When the operation of a control appears to cause an unusual response or a lack of it, the reason can be found by checking through the manual for other references to that control. For example, the AC DC key sometimes does not select DC. Checking through the manual reveals that this key is disabled for both SINAD and distortion measurements. In this case, selecting DIST'N OFF re-enables the key for other measurements.

FRONT PANEL

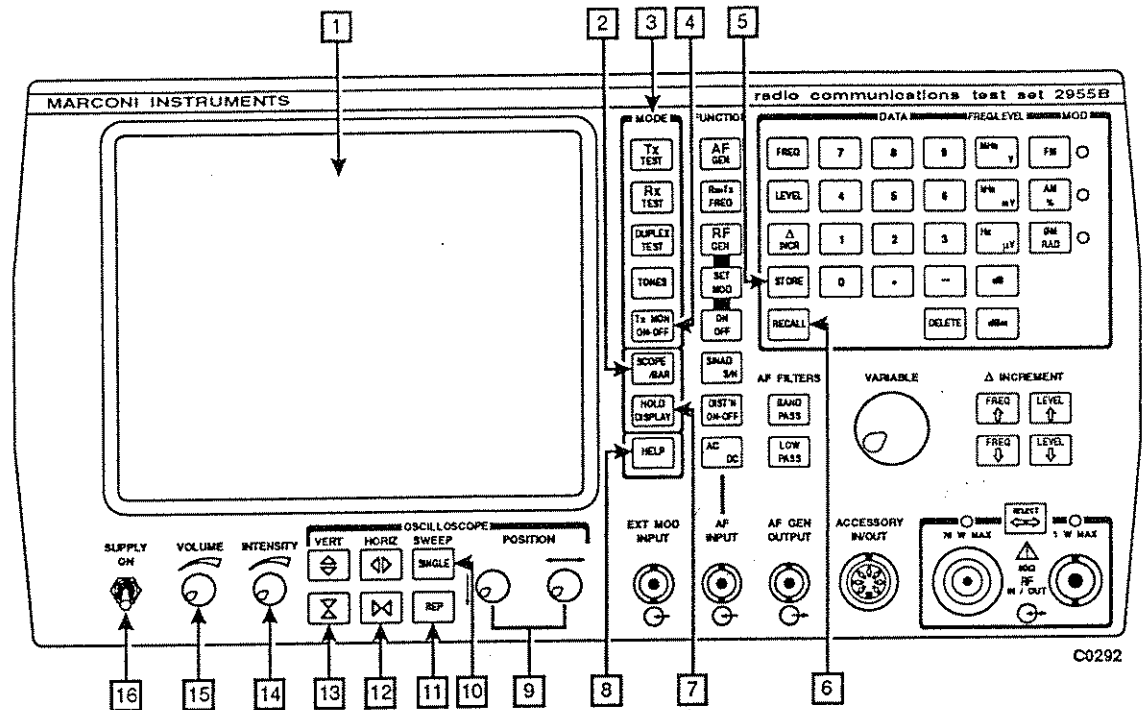

Fig. 3-1 Front panel

- 1 Display. This shows one of the following:-
 - (a) Instrument settings and measurement results (in the upper half of the screen) with bar charts or an oscilloscope graticule and trace (in the bottom half of the screen).
 - (b) One of the menus for using the seven blue keys 2, 3, 4 and 7 and the grey key 8 as soft keys to select a programmed function.

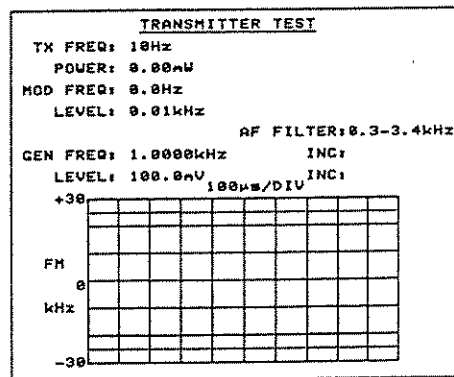

Fig. 3-2 Oscilloscope display

Under difficult viewing conditions, the Viewing Hood Assembly (part no. 54150-022P), available as an optional accessory, can be used. This folding assembly clips under the screen bezel.

- 2** **SCOPE/BAR key.** When SCOPE is selected, the bottom half of the screen shows a single trace on a graticule of 6 x 10 squares. The trace is of the demodulated audio in transmitter testing and of the applied audio in receiver testing. When BAR is selected, the bottom half of the screen shows vertical bar charts, each with an A for autoranging or an H for hold as described under **12**. Also, this is used as a soft key to select a programmed function from menus which are shown alongside on the screen.
- 3** **MODE keys.** These are used to select TRANSMITTER TEST, RECEIVER TEST, DUPLEX or TONES. Also, these are used as soft keys to select programmed functions from menus which are shown alongside on the screen.
- 4** **TX MON ON-OFF key.** When Option 1 is fitted, enables and disables TRANSMITTER MONITOR testing with the off-air receiver. When Option 1 is not fitted, a message is displayed. Returns to the previous mode when the RETURN soft key is pressed. It is also used as a soft key to select programmed functions from menus which are shown alongside on the screen.
- 5** **STORE key.** Stores front panel settings. See under 'Store and recall operation'.
- 6** **RECALL key.** Recalls front panel settings previously stored using **5**. See under 'Store and recall operation'.
- 7** **HOLD DISPLAY key.** Freezes the display including the oscilloscope or bar charts (but not the trace). All the front panel keys except HOLD DISPLAY are inoperable. When the key is pressed again, the hold is released. Also, this is used as a soft key to select a programmed function from menus which are shown alongside on the screen.
- 8** **HELP key.** Displays the HELP menu. See under 'Help key operation'. Also, this is used as a soft key to select a programmed function from menus which are shown alongside on the screen.
- 9** **POSITION controls.** Used to vary the trace position, both horizontally and vertically.
- 10** **SINGLE SWEEP key.** Selects only one sweep of the oscilloscope trace to occur after a trigger and implements the storage oscilloscope facility. Resets the sweep if it is part way through. Also, this is used as a soft key for bar charts to change between autoranging (shown by A) and holding the range (shown by H) when a particular bar chart has been selected (using **12**).
- 11** **REP SWEEP key.** Selects repetitive sweeping of the oscilloscope trace on auto trigger.
- 12** **HORIZ keys.** Change the oscilloscope horizontal scale in time per division. Also, the upper key is used as a soft key to select (by pressing once or more) a particular bar chart (shown by A or H flashing) to change between autoranging and holding the range (by using **10** and then this upper key again).
- 13** **VERT keys.** In the TRANSMITTER TEST mode, these change the oscilloscope vertical scale in modulation units per division. In the RECEIVER TEST mode, they change the oscilloscope vertical scale in volts per division.

- 14 INTENSITY control. Varies the brightness of the display.
- 15 VOLUME control. Controls the output of the built-in loudspeaker which is used for monitoring and for alarms.
- 16 SUPPLY switch. When it is switched to ON, the instrument enters the RECEIVER TEST mode.

REAR PANEL

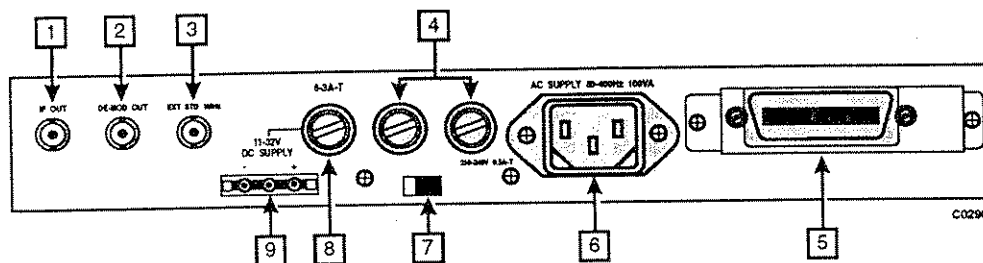

Fig. 3-3 Rear panel

- 1 IF OUT socket. BNC socket. Supplies a 110 ± 10 kHz IF output. Do not load with less than $10 \text{ k}\Omega$.
- 2 DE-MOD OUT socket. BNC socket. Supplies a demodulated output from the modulation meter. Do not load with less than $10 \text{ k}\Omega$. In DUPLEX test mode, the output is not normally continuous (due to multiplexing of internal circuits).
To make the output continuous in DUPLEX test mode, press the MODE key which is marked TONES. This changes the display but not the settings. Press the RETURN key to restore the DUPLEX test display.
- 3 EXT STD 1 MHz socket. BNC socket. For the connection of an external 1 MHz standard. Connection automatically phase locks the internal standard to the external signal.
- 4 AC supply fuses. Time delay, cartridge type, for fusing 6. For details, see under 'Power supply requirements' in Chap. 2.
- 5 GPIB Interface Unit. For remote operation of the instrument.
- 6 AC supply socket. 3-pin AC supply input connector.
- 7 Supply voltage selector. To change the range.
- 8 DC SUPPLY fuse. Time delay, cartridge type, for fusing 9. For details, see under 'Power supply requirements' in Chap. 2.
- 9 DC SUPPLY socket. 3-way socket for connecting to the optional Battery Pack or to an external battery. For fitting the Battery Pack and for operating details, see under 'Fitting the battery option' in Chap. 2.

ACCESSORIES

600 Ω Interface Unit

This is available as an optional accessory. It consists of a Balanced to Unbalanced Converter and a 20 dB Attenuator. See under 'Accessories' in Chap. 1.

The high impedance of the AF INPUT and the low impedance of the AF GEN OUTPUT is converted into 600 Ω balanced impedances.

A low impedance output from the AF GEN OUTPUT is attenuated by 20 dB.

See the Operating Instructions for the accessory and under 'AF generator operation' and 'AF voltmeter operation'.

Directional Power Heads

These are available as optional accessories. See under 'Accessories' in Chap. 1.

They enable measurement of forward power, reverse power and VSWR in coaxial RF transmission lines and antenna systems. The HF model is for 1 to 50 MHz and the UHF model is for 25 to 1000 MHz.

See The Operating Manual for the accessory and under 'RF power meter operation'.

Printer

This is available as an optional accessory. See under 'Accessories' in Chap. 1.

See the Instruction Manual for the accessory and under 'Printer'.

Transmitter testing

AF GENERATORS

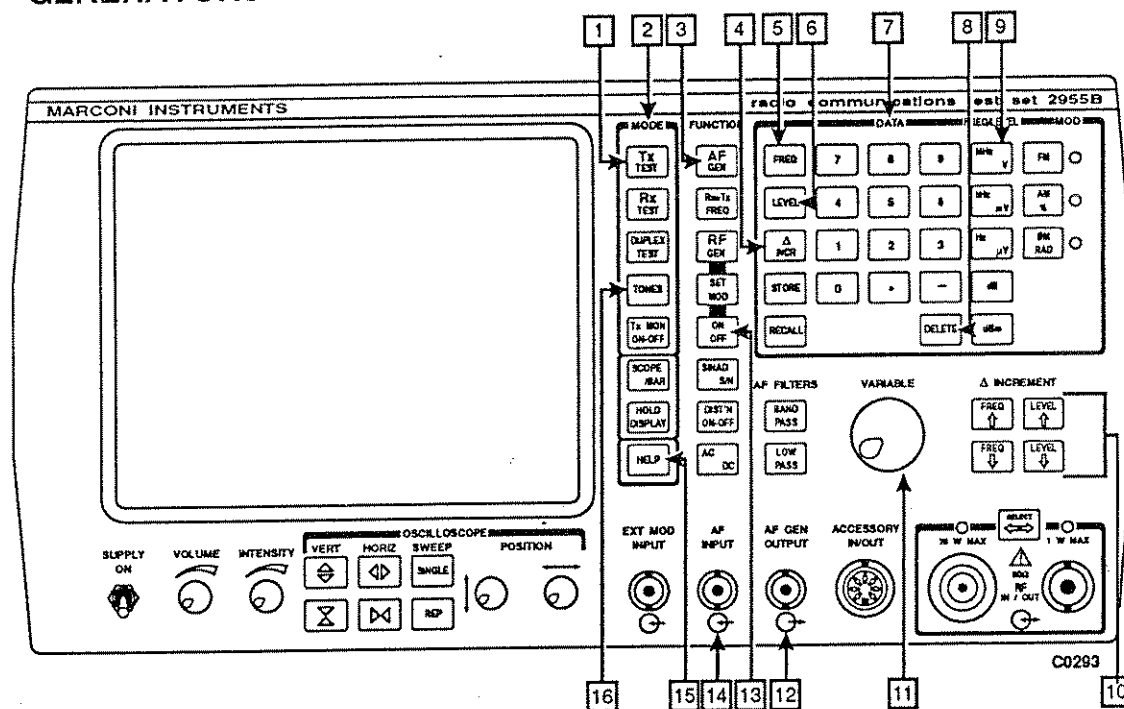

Fig. 3-4 AF generator controls and connectors

AF generator controls and connectors

- 1 TX TEST key. Used to select the TRANSMITTER TEST mode. Connects the AF generator to the AF GEN OUTPUT socket 12.
- 2 MODE keys. Used as soft keys to select programmed functions when menus are shown alongside on the screen.
- 3 AF GEN key. Enables the two internal AF generators.
- 4 Δ INCR key. Follows a FREQ 5 or LEVEL 6 entry so that the entered data is recognized as an increment or decrement.
- 5 FREQ key. Precedes a keypad 7 entry so that the entered data is recognized as a frequency.
- 6 LEVEL key. Precedes a keypad 7 entry so that the entered data is recognized as a level.
- 7 DATA keypad. For data entry using numerals 0 to 9, decimal point and minus sign.
- 8 DELETE key. Deletes a preceding digit, decimal point or minus sign which has been entered on the keypad 7.

- 9 **FREQ/LEVEL keys.** For defining units of frequency or level. One of these terminates the data entry.
- 10 **Δ INCREMENT keys.** Increase and decrease the frequency and the level by the increments which have been set using 4 .
- 11 **VARIABLE control.** Analogue control which varies the smallest increment of the function data. Step size is independent of 4 and depends upon range. The level or frequency assignment is shown in reverse video on the screen.
- 12 **AF GEN OUTPUT socket.** BNC connector. Supplies one or two outputs in the range 10 Hz to 20 kHz for single-tone or two-tone operation. Impedance <math><5 \Omega</math>.
- 13 **ON OFF key.** Enables and disables the AF generators.
- 14 **AF INPUT socket.** BNC socket. For the audio input. Impedance 1 MΩ.
- 15 **HELP key.** Enables access to the CHANGE PARAMETERS menu for selection of the 600 Ω Balanced Converter and 20 dB Attenuator.
- 16 **TONES key.** Used to select the TONES menu.

AF generator operation

AF generator operation consists of initial actions (1) to (4) and then, for one or both of the two AF generators, AF frequency setting (5) to (7) and level setting (8) to (11) as follows:-

- (1) Select TX TEST 1 . The TRANSMITTER TEST display appears.

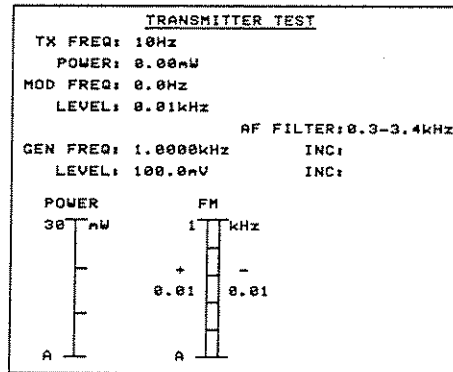

Fig. 3-5 TRANSMITTER TEST display

- (2) Press AF GEN **[3]** . This selects the first AF generator. AF GEN is shown in reverse video on the screen. To select the second AF generator, press AF GEN **[3]** followed by 2 on the keypad **[7]** . After this, use AF GEN **[3]** followed by 1 on the keypad **[7]** when you require to go back to the first AF generator. For the second AF generator, 2 is shown on the display. For the first AF generator, 1 is shown on the display only when both are enabled. Initially, the first AF generator is enabled and the second is OFF . To enable and disable each AF generator, press the ON OFF key **[13]** .
- (3) Connect the unit under test to the AF GEN OUTPUT socket **[12]** .
- (4) To use the 600 Ω Interface Unit (e.g. for testing telephone lines), connect it to the AF GEN OUTPUT socket **[12]** and to the AF INPUT socket **[14]**. The AF GEN LEVEL setting on the TRANSMITTER TEST display is shown in dBm or V. To change the unit, press the HELP key **[15]**, select the CHANGE PARAMETERS option and use the soft key for the 600 Ω BALANCED AF ACCESSORY. Select FITTED for dBm. LEVEL settings can then be entered in dBm or V. When the instrument is switched off and then on again, any V setting is converted to dBm. Select NOT FITTED for V. LEVEL settings can then be entered in V only.
- (5) Select FREQ **[5]** . The frequency to be changed is shown in reverse video. Enter the data on the keypad **[7]** , ending with the frequency terminator **[9]** . To enter 1.235 kHz, use the following:-



If a mistake is made during data entry, press DELETE **[8]** and then enter the correct character. When, however, the terminator **[9]** has been pressed, re-enter the complete data. If incorrect data has been entered (e.g. a frequency outside the range of the instrument), the terminator is ignored and the entry is not accepted. Use DELETE and then re-enter the data.

- (6) If required, set the frequency increment/decrement by selecting Δ INCR **[4]** and entering the data, ending with the frequency terminator. To enter 500 Hz steps, use the following:-

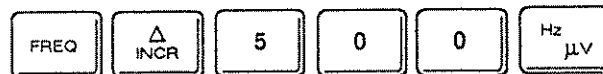

In the example, FREQ can be omitted since it has been previously entered in (5).

- (7) Having set the step size, the frequency can be adjusted by repeatedly pressing one of the Δ INCREMENT keys **[10]** , FREQ \uparrow for an increment or FREQ \downarrow for a decrement. For fine frequency control, use the VARIABLE control **[11]** .

- (8) Select LEVEL [6]. The level to be changed is displayed in reverse video. Enter the data on the keypad [7], ending with the level terminator [9]. To enter 50 mV, use the following:-



- (9) If required, set the level increment/decrement by selecting Δ INCR [4] and entering the data, ending with the level terminator. To enter 200 mV steps, use the following:-



In the example, LEVEL can be omitted since it has been previously entered in (8).

- (10) Having set the step size, the level can be adjusted by repeatedly pressing one of the Δ INCREMENT keys [10], LEVEL \uparrow for an increment or LEVEL \downarrow for a decrement. For fine level control, use the VARIABLE control [11].
- (11) To use the 20 dB Attenuator, connect it to the AF GEN OUTPUT socket [12]. To reduce the displayed AF GEN LEVEL, press the HELP key [15], select the CHANGE PARAMETERS option and use the soft key for the 20 dB ATTENUATOR ACCESSORY. Select FITTED for a reduction of 20 dB or NOT FITTED for the actual level at the socket. When FITTED has been selected, A in reverse video is displayed alongside the FREQ setting.

TONES menu

This gives access to the TX AUDIO SETUP menu as described below in addition to other options which are described under 'Signalling codes testing'.

In the TRANSMITTER TEST mode, press the TONES key [15]. The TONES menu appears.

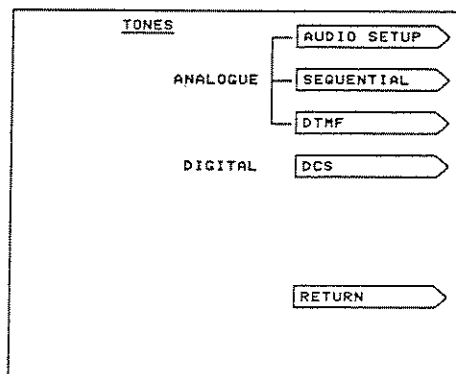

Fig. 3-6 TONES menu

Audio setup

Under the TONES menu, press the AUDIO SETUP key. The TX AUDIO SETUP menu appears.

TX AUDIO SETUP	
GEN1 FREQ: 1.0000kHz	INC:
LEVEL: 100.0mV	INC:
GEN2 FREQ: 1.0000kHz	INC:
LEVEL: 100.0mV	2T INC:
LEVEL1-LEVEL2:	LOCK
GEN1 SHAPE: SINE	SHAPE
GEN2 SHAPE: SINE	RETURN

Fig. 3-7 TX AUDIO SETUP menu

This menu is an alternative display under which the AF generator frequencies and levels can be set, both being shown together. In addition, the AF generators can be enabled and disabled, the levels can be locked together and the waveforms can be selected.

To enable or disable the AF generators, select the generator (as described under 'AF generator operation') and then use the ON OFF key **13** to select enabled or OFF. When both AF generators are enabled, 2T (two tone) is shown on the display.

To lock the level of GEN2 so that it is the same as the level of GEN1, press the LOCK key to select LOCKED.

To change a waveform, select the AF generator and then use the SHAPE key to select SINE, SQUARE, TRIANGLE or SAW-TOOTH.

For using the 600 Ω Interfact Unit or a 20 dB Attenuator, see under 'AF generator operation'. LEVEL settings unit, reduction of the displayed LEVEL and A in reverse video are as on the TRANSMITTER TEST display.

Pressing RETURN restores the TRANSMITTER TEST display.

RF POWER METER

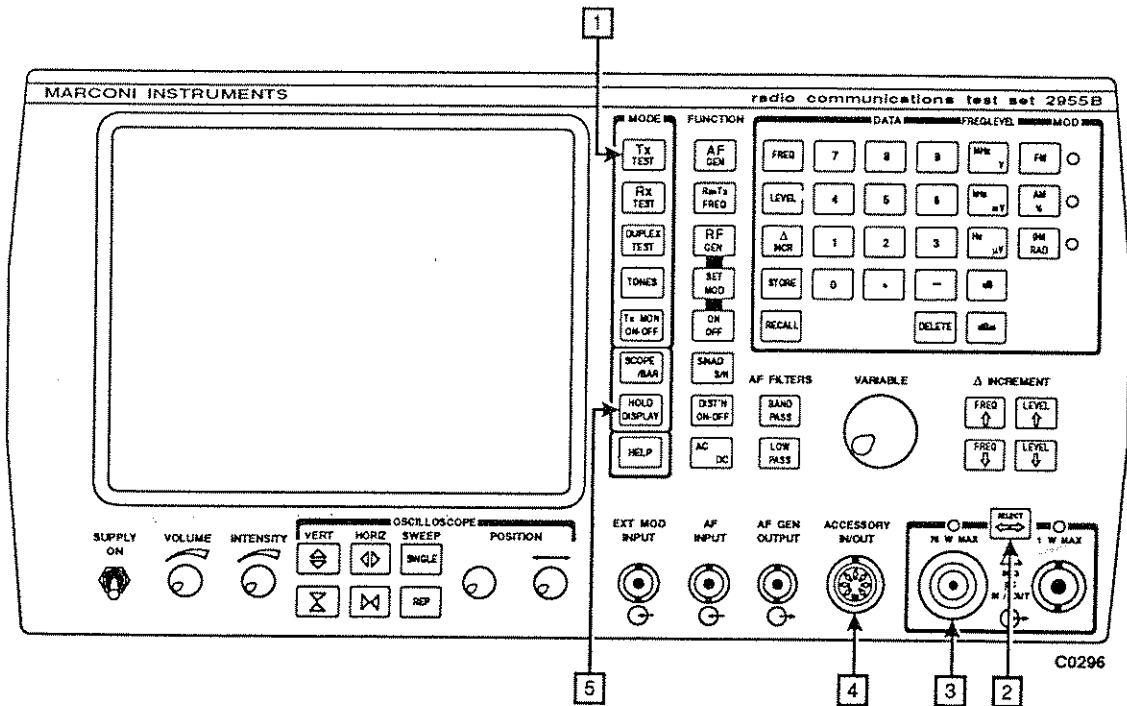

Fig. 3-8 RF power meter controls and connectors

RF power meter controls and connectors

- 1 TX TEST key. Used to select the TRANSMITTER TEST mode. Connects the RF power meter and the RF counter to the RF IN/OUT N socket 3.
- 2 SELECT key and LEDs. For selecting RF IN/OUT N socket 3. LED lights above the socket when it is correctly selected.
- 3 RF IN/OUT N socket. For the transmitter output. A temperature sensor detects excessive power being applied. Impedance 50 Ω .
- 4 ACCESSORY socket. DIN 7-pin connector for the external RF directional power head option.
- 5 HOLD DISPLAY key. The display, including the oscilloscope or bar charts (but not the trace), is frozen. All keys, except HOLD DISPLAY, are inoperable. When the key is pressed again, the hold is released.

RF power meter operation

Proceed as follows:-

- (1) Select TX TEST 1 . The TRANSMITTER TEST display appears.

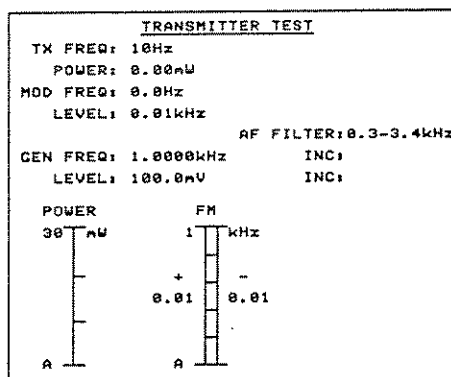

Fig. 3-9 TRANSMITTER TEST display

- (2) Press SELECT 2 , if necessary, to light the LED above the RF IN/OUT N socket 3 .
- (3) Connect the unit under test to the RF IN/OUT N socket 3 .
- (4) The instrument automatically tunes to the transmitter's RF frequency.
- (5) If the applied power exceeds that allowable, the display flashes REMOVE RF INPUT followed shortly by an audible warning.
- (6) The applied RF power and carrier frequency are displayed on the screen.
- (7) If required, the transmitter can be tuned for minimum or zero indicated offset using the 2955B. See 'Transmitter frequency adjustment' at the end of this chapter.
- (8) If required, connect the RF Directional Power Head to the ACCESSORY socket 4 for automatic measurement and display of forward and reverse power and of VSWR.

MODULATION METER

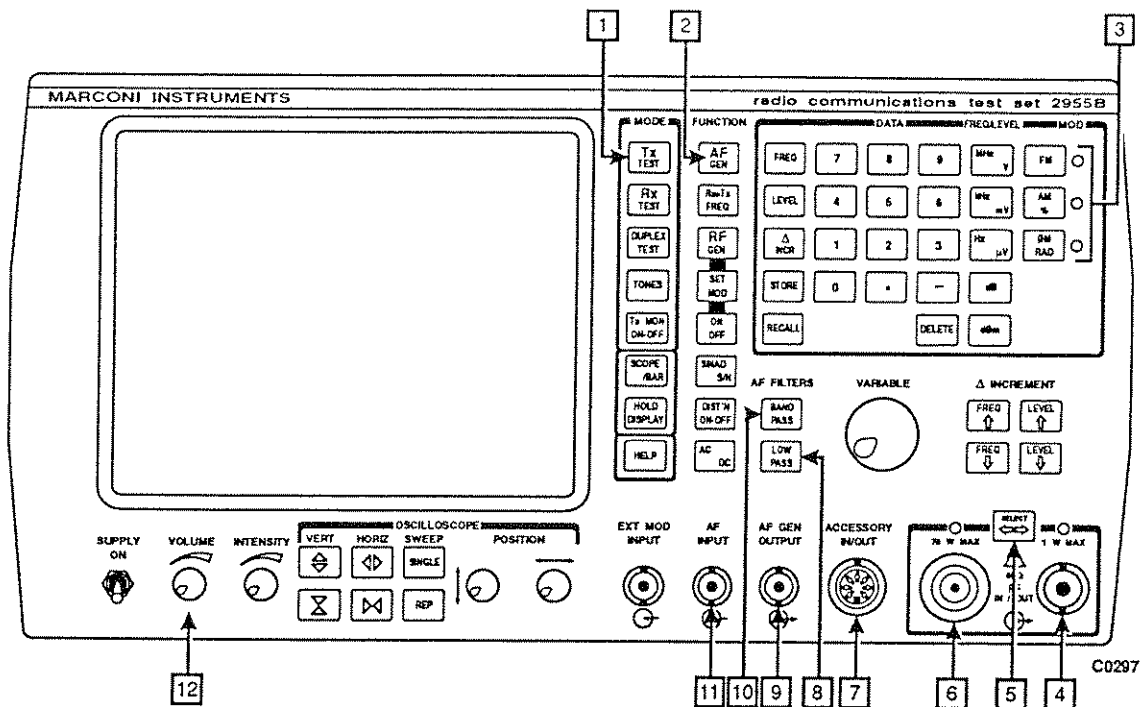

Fig. 3-10 Modulation meter controls and connectors

Modulation meter controls and connectors

- 1 TX TEST key. Used to select the TRANSMITTER TEST mode. Connects the modulation meter to RF IN/OUT socket 4 or 6 and connects the AF generator to the AF GEN OUTPUT socket 9.
- 2 AF GEN key. Enables the internal AF generator to supply a modulating signal to socket 9.
- 3 MOD keys and LEDs. Enable the type of modulation to be entered. LED lights to show that FM, AM or Φ M has been selected.
- 4 RF IN/OUT BNC socket. For the Telescopic Antenna which is available as an optional accessory. Automatically protected against excessive power.
- 5 SELECT key and LEDs. For selecting RF IN/OUT BNC or N socket 4 or 6. LED lights above the socket selected.
- 6 RF IN/OUT N socket. For high level inputs. A temperature sensor detects excessive power being applied. Impedance 50 Ω .
- 7 ACCESSORY socket. DIN 7-pin connector for external loudspeaker or earphones. Connection does not disable the internal loudspeaker. Control of volume is by 12.
- 8 LOW PASS key. Selects a 300 Hz or a 15 kHz low-pass filter.

- 9 AF GEN OUTPUT socket. BNC connector. Supplies a modulating output in the range 10 Hz to 20 kHz. Impedance $<5 \Omega$.
- 10 BAND PASS key. Selects a 0.3 to 3.4 kHz band-pass filter or an external filter.
- 11 AF INPUT socket. BNC connector. For input from an external filter.
- 12 VOLUME control. Controls the volume of the internal loudspeaker and of a loudspeaker or earphones connected to 7 .

Modulation meter operation

To measure AM depth or FM and Φ M deviation, proceed as follows:-

- (1) Select TX TEST 1 . The TRANSMITTER TEST display appears.

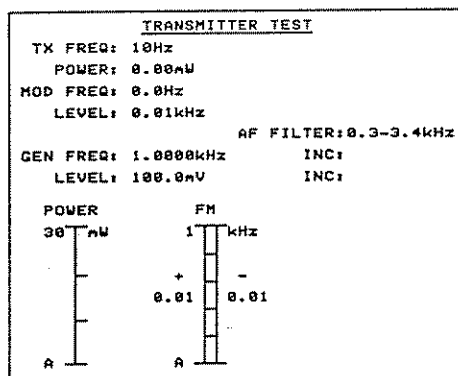

Fig. 3-11 TRANSMITTER TEST display

- (2) Connect the transmitter output to the RF IN/OUT N socket 6 . Alternatively, connect the Telescopic Antenna (available as an optional accessory) to the RF IN/OUT BNC socket 4 .
- (3) The instrument automatically tunes to the transmitter's frequency. If required, the transmitter can be tuned for minimum or zero indicated offset using the 2955B. See 'Transmitter frequency adjustment' at the end of this chapter.
- (4) Press SELECT 5 until the LED lights above the RF IN/OUT N connector 6 or the BNC socket 4 .
- (5) Select modulation type FM, AM or Φ M 3 . If greater than 50% AM is applied, there is a possibility that false readings may occur. Use keyboard tuning of the modulation meter as for 'Transmitter frequency adjustment' at the end of this chapter.
- (6) Press BAND PASS 10 once or twice as necessary to select the 0.3 to 3.4 kHz BP filter or an external filter or press LOW PASS 8 once or twice as necessary to select a 300 Hz or 15 kHz LP filter. The external filter is connected between the DE-MOD OUT socket (on the rear) and the AF INPUT socket 11 .

LOCAL OPERATION

- (7) If required, modulate the transmitter's carrier by connecting the AF GEN OUTPUT socket 9 to the microphone input of the transmitter. Set the frequency and level as under 'AF generator operation'.
- (8) Read the displayed % depth for AM or the deviation and symmetry for FM and Φ M.
- (9) Adjust VOLUME control 12 to monitor the demodulated signal using the internal loudspeaker, an external loudspeaker or earphones using the ACCESSORY socket 7.
- (10) The demodulated output is available at the DE-MOD OUT socket on the rear panel.

DISTORTION AND NOISE METER

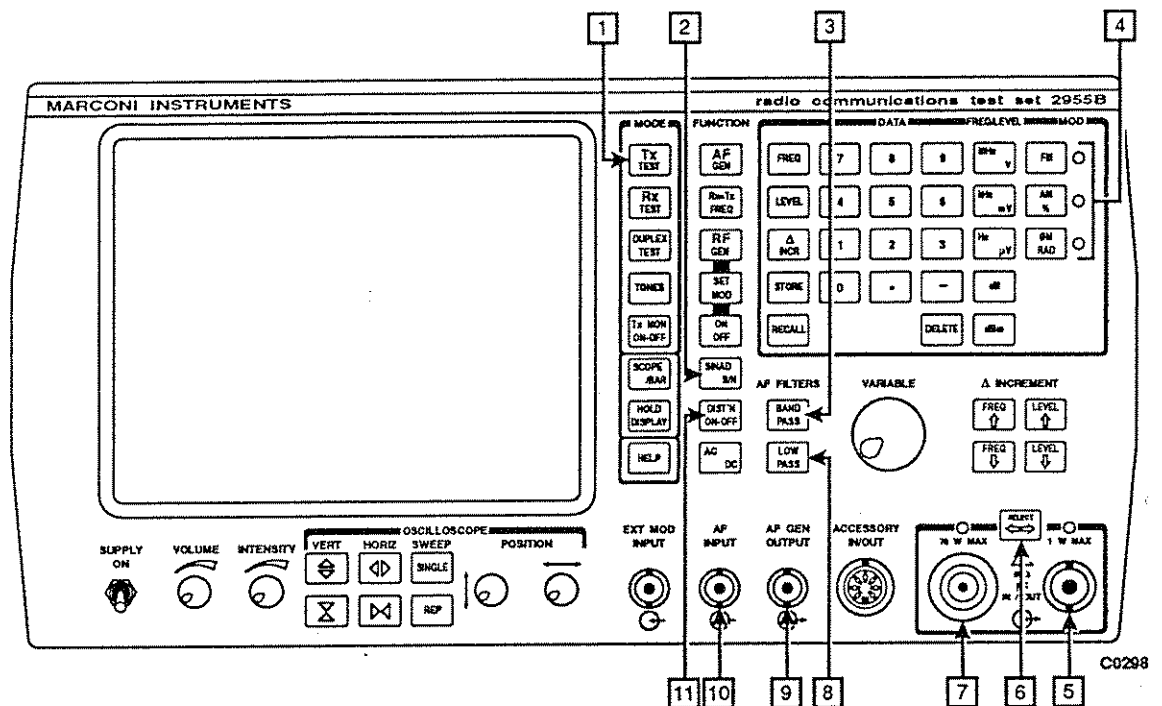

Fig. 3-12 Distortion and noise meter controls and connectors

Distortion and noise meter controls and connectors

- 1 **TX TEST key.** Used to select the TRANSMITTER TEST mode. Connects the distortion meter to the RF IN/OUT BNC socket 5 or N socket 7 and connects the AF generator to the AF GEN OUTPUT socket 9.
- 2 **SINAD S/N key.** Selects SINAD or signal/noise. When SINAD is selected, causes the AF generator to generate a 1 kHz tone to socket 9. The display indicates when SINAD or S/N is selected.
- 3 **BAND PASS key.** Selects a 0.3 to 3.4 kHz band-pass filter or an external filter.
- 4 **MOD keys and LEDs.** Enable the type of modulation to be entered. LED lights to show that the FM, AM or Φ M (FM with de-emphasis) route to the demodulator has been selected.
- 5 **RF IN/OUT BNC socket.** For the transmitter input. Automatically protected against excessive power. Impedance 50 Ω .
- 6 **SELECT key and LEDs.** For selecting RF IN/OUT socket 5 or 7. LED lights above the socket selected.
- 7 **RF IN/OUT N socket.** For the transmitter input. A temperature sensor detects excessive power being applied.

- 8 LOW PASS key. Selects a 300 Hz or a 15 kHz low-pass filter.
- 9 AF GEN OUTPUT socket. Output used to modulate the transmitter under test with a 1 kHz tone. Impedance <math>< 5 \Omega</math>.
- 10 AF INPUT socket. BNC connector. For input from an external filter.
- 11 DIST'N ON-OFF key. Causes the AF generator to generate a 1 kHz tone to socket 9. The display indicates when distortion is selected.

Distortion and noise meter operation

To make a transmitter distortion measurement, proceed as follows:-

- (1) Select TX TEST 1. The TRANSMITTER TEST display appears.

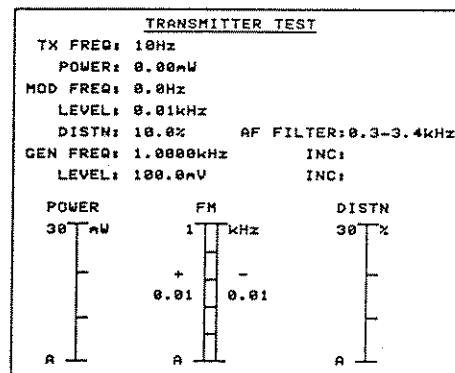

Fig. 3-13 TRANSMITTER TEST display

- (2) Connect the transmitter output to the RF IN/OUT BNC connector 5 for a low level RF output or to the RF IN/OUT N connector 7 for a high level RF output.
- (3) Press SELECT 6 and ensure that the LED lights above the socket selected.
- (4) The instrument automatically tunes to the transmitter's frequency. If required, the transmitter can be tuned for minimum or zero indicated offset using the 2955B. See 'Transmitter frequency adjustment' at the end of this chapter.
- (5) Connect the AF GEN OUTPUT socket 9 to the transmitter's microphone input to provide amplitude, frequency or phase modulation.
- (6) Press DIST'N ON-OFF 11 until DISTN is displayed. This causes a 1 kHz tone to be generated to socket 9 to modulate the transmitter.
- (7) Select modulation FM, AM or Φ M 4.

- (8) The 0.3 to 3.4 kHz BP filter is automatically selected. Press LOW PASS **[8]** once or twice as necessary to select a 300 Hz or 15 kHz LP filter. Press BAND PASS **[3]** once or twice as necessary to return to the 0.3 to 3.4 kHz BP filter or to an external filter. The external filter is connected between the DE-MOD OUT socket (on the rear) and the AF INPUT socket **[10]**.
- (9) Read the % distortion from the display.
- (10) Press the SINAD S/N key **[2]** until SINAD is displayed.
- (11) Read the SINAD in dB from the display.
- (12) Press the SINAD S/N key **[2]** until S/N is displayed.
- (13) Read the S/N from the display.
- (14) To return to normal operation, select DIST'N OFF using key **[11]**.

APPLICATIONS

Transmitter frequency adjustment

If the transmitter setting (e.g. 400 MHz), does not agree with the measured frequency (e.g. 400.000100 MHz), the offset can be corrected as follows:-

- (1) With the TRANSMITTER TEST mode selected, press FREQ and then enter the transmitter setting (e.g. 400 MHz).
- (2) The offset is displayed as a positive or negative value (e.g. +100 Hz).
- (3) Adjust the transmitter's internal frequency while observing the offset. Tune until negative values are seen and then readjust positively for zero offset.
- (4) AUTO TUNE appears on the screen alongside the TX TEST key. Press this key. The 2955B automatically tunes to and displays the transmitter's corrected frequency.

Receiver testing

RF GENERATOR

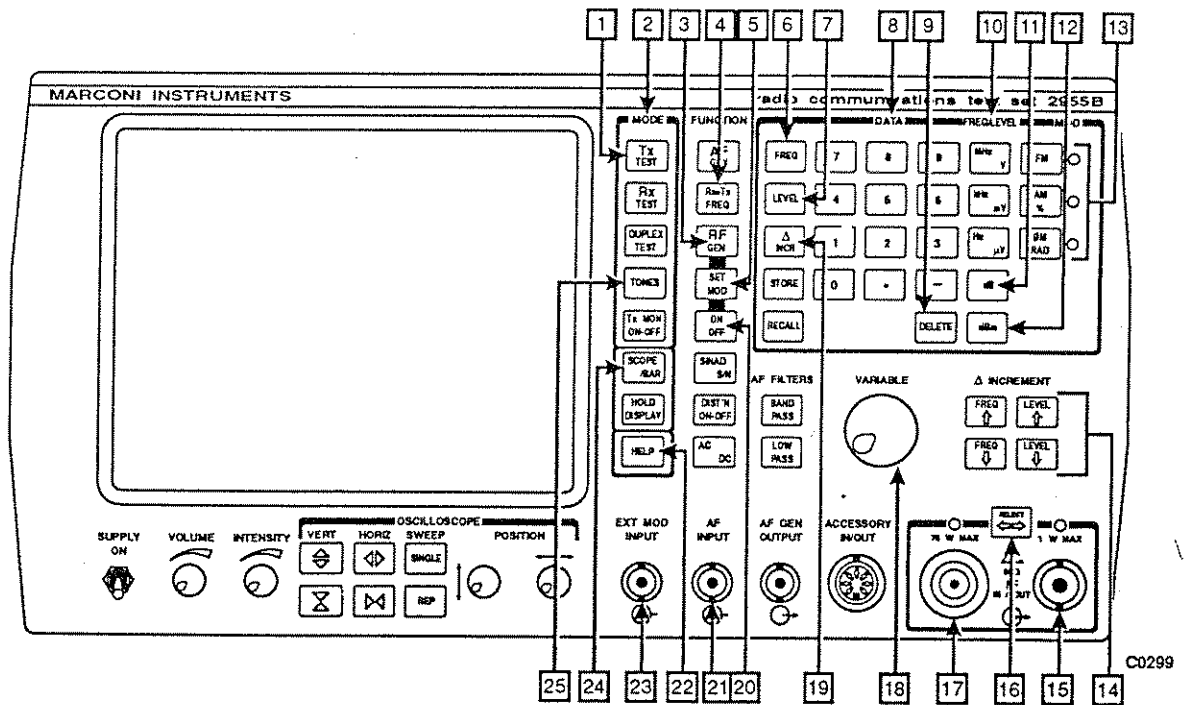

Fig. 3-14 RF generator controls and connectors

RF generator controls and connectors

- 1 RX TEST key. Used to select the RECEIVER TEST mode. Connects the RF generator to the RF IN/OUT BNC and N sockets 15 and 17.
- 2 MODE keys. Used as soft keys to select programmed functions when menus are shown alongside on the screen.
- 3 RF GEN key. Enables the internal RF generator.
- 4 RX=TX FREQ key. Used only when in the TRANSMITTER TEST mode with the transmitter keyed up. Tunes the RF generator to the frequency of a transmitter connected to 15 or 17. The receiver section of a transceiver can be tested without having to enter the frequency.
- 5 SET MOD key. Enables the internal RF generator modulation system. Followed by a FREQ 6 or LEVEL 7 entry to set the modulation value.
- 6 FREQ key. Precedes a keypad 8 entry so that the entered data is recognized as a frequency.

- [7] LEVEL key.** Precedes a keypad **[8]** entry so that the entered data is recognized as a level. As supplied, each 2955B is programmed either for European or for North American standards. European practice is to show the output level as PD or EMF.
- [8] DATA keypad.** For data entry using numerals 0 to 9, decimal point and minus sign.
- [9] DELETE key.** Deletes a preceding digit, decimal point or minus sign which has been entered on the keypad **[8]**.
- [10] FREQ/LEVEL keys.** For defining units of frequency or level. Unless entering modulation, terminates the data entry.
- [11] dB key.** For defining the RF level as dB μ V.
- [12] dBm key.** For defining the RF level as dBm.
- [13] MOD keys and LEDs.** Enable the preceding keypad **[8]** entry to be recognized as a frequency modulation deviation, amplitude modulation percentage or phase modulation deviation. Activates the modulator for the RF generator. LED lights to show that FM, AM or Φ M has been selected. Modulation is switched on and off by **[20]**.
- [14] Δ INCREMENT keys.** Increase and decrease the frequency and the level by the increments which have been set using **[19]**.
- [15] RF IN/OUT BNC socket.** For RF generator output levels up to 225 mV. Impedance 50 Ω . Automatically protected against excessive reverse power during duplex operation.
- [16] SELECT key and LEDs.** For selecting RF IN/OUT socket **[15]** or **[17]**. LED lights above the socket selected.
- [17] RF IN/OUT N socket.** For RF generator output levels up to 22.5 mV. Impedance 50 Ω .
- [18] VARIABLE control.** Analogue control which varies the smallest increment of the function data. Step size is independent of **[19]** and depends upon range. The level for frequency assignment is shown in reverse video on the screen.
- [19] Δ INCR key.** Precedes a keypad **[8]** entry so that the entered data is recognized as an increment or decrement.
- [20] ON OFF key.** Enables and disables the RF output when **[3]** has been selected. Enables and disables the modulation, both internal and external, when **[5]** has been selected. OFF appears in reverse video when the RF output or the modulation is disabled. Does not affect LEDs **[13]**.
- [21] AF INPUT socket.** BNC socket. For the audio input. Impedance 1 M Ω .
- [22] HELP key.** Enables access to the CHANGE PARAMETERS menu for selection of EMF (unloaded) or PD (loaded).

LOCAL OPERATION

- 23 EXT MOD INPUT socket. BNC socket. For the application of an external modulating signal. To set the level of and to enable and disable the external modulation, see later under 'Modulation setup'.
- 24 SCOPE/BAR key. To select the oscilloscope or the bar chart to measure the audio input.
- 25 TONES key. Used to select the TONES menu.

RF generator operation

RF generator operation consists of initial action (1) to (3), RF frequency setting (4) to (6), level setting (7) to (9) and modulation setting (10) to (12) followed by (13) to (15) for AM, (16) to (18) for Φ M, (19) to (21) for FM and then (22). (23) and (24) are for external modulation. Proceed as follows:-

- (1) Select RX TEST . The RECEIVER TEST display appears.

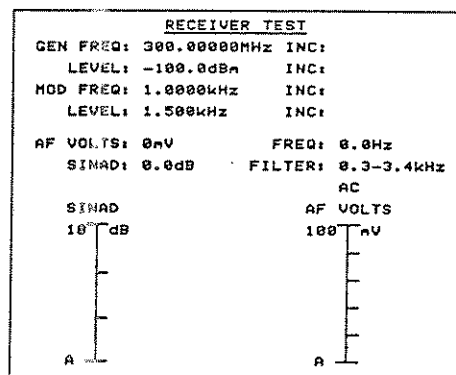

Fig. 3-15 RECEIVER TEST display

- (2) Select function RF GEN .
- (3) Connect the unit under test to RF IN/OUT BNC socket or to N socket . Press SELECT until the LED lights above the socket selected for the RF output.
- (4) Select FREQ . The frequency to be changed is shown in reverse video. Enter the data on the keypad , ending with the frequency terminator or (for dB μ V) or (for dBm). To enter, 123.5 MHz, use the following:-



If a mistake is made during data entry, press DELETE [9] and then enter the correct character. When, however, the terminator [10] has been pressed, re-enter the complete data. If incorrect data has been entered (e.g. a frequency outside the range of the instrument), the terminator is ignored and the entry is not accepted. Use DELETE and then re-enter the data.

- (5) If required, set the frequency increment/decrement by selecting Δ INCR [19] and enter the data, ending with the frequency terminator. To enter 500 kHz steps, use the following:-



In the example, FREQ can be omitted since it has been previously entered in (4).

- (6) Having set the step size, the frequency can be adjusted by repeatedly pressing one of the Δ INCREMENT keys [14], FREQ \uparrow for an increment or FREQ \downarrow for a decrement. For fine frequency control, use the VARIABLE control [18].
- (7) Select LEVEL [7]. The level to be changed is displayed in reverse video. Enter the data on the keypad [8], ending with the level terminator [10]. To change between PD (loaded) and EMF (unloaded), press the HELP key [22] and then continue as described under 'RF level selection'. Switch the RF generator on or off as required using the ON OFF key [20]. To enter -34 dBm, use the following:-



- (8) If required, set the level increment/decrement by selecting Δ INCR [19] and enter the data, ending with the level terminator. To enter 0.5 dB steps, use the following:-



In the example, LEVEL can be omitted since it has been previously entered in (7).

- (9) Having set the step size, the level can be adjusted by repeatedly pressing one of the Δ INCREMENT keys [14], FREQ \uparrow for an increment or FREQ \downarrow for a decrement. For fine level control, use the VARIABLE control [18].
- (10) Press SET MOD [5]. This selects the first modulation generator. MOD is shown in reverse video on the screen. To select the second modulation generator, press SET MOD [5] followed by 2 on the keypad [8]. After this, use SET MOD [5] followed by 1 on the keypad [8] when you require to go back to the first modulation generator. For the second modulation generator, 2 is shown on the display. For the first modulation generator, 1 is shown on the display only when both are enabled. Initially, the first modulation generator is enabled and the second is OFF. To enable and disable each modulation generator, press the ON OFF key [20].

- (11) Select FREQ **6** and then enter the data, ending with the frequency terminator **10**. To enter 1.5 kHz AM, FM or Φ M, use the following:-

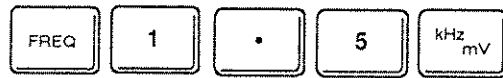

- (12) If required, the modulation frequency can be adjusted as for (5) and (6).
 (13) For amplitude modulation, select LEVEL **7** and then enter the modulation depth in %. Terminate with key **13** and check that the associated lamp lights. To enter 60% AM, use the following:-



- (14) If required, set the modulation value increment/decrement by selecting Δ INCR **19** and entering the step size. To enter a 2% step, use the following:-



In the example, LEVEL can be omitted since it has been previously entered in (13).

- (15) Adjust the modulation value as for (9).
 (16) For phase modulation, select LEVEL **7** and then enter the deviation in radians. Terminate with key **13** and check that the associated lamp lights. To enter 6 radians, use the following:-



- (17) If required, set the modulation value increment/decrement by selecting Δ INCR **19** and entering the step size. To enter a 2 radians step, use the following:-



In the example, LEVEL can be omitted since it had been entered in (16).

- (18) Adjust the modulation value as for (9).
 (19) For frequency modulation, select LEVEL **7** and then enter the deviation, ending with the frequency terminator **10**. Press FM **13** and check that the associated lamp lights. To enter 5 kHz FM deviation, use the following:-

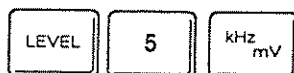

- (20) If required, set the modulation value increment/decrement by selecting Δ INCR [19] and entering the step size. To enter, a 4 kHz step, use the following:-



In the example, LEVEL can be omitted since it has been previously entered in (19).

- (21) Adjust the modulation value as for (9).
- (22) Switch the modulation (both internal and external, if applied) on or off as required using the ON OFF key [20]. The off condition is shown in reverse video on the display.
- (23) For external modulation, connect the signal to the EXT MOD INPUT socket [23].

TONES menu

This gives access to the RX MODULATION SETUP menu as described below in addition to other options which are described in under 'Signalling codes testing'.

In the RECEIVER TEST mode, press the TONES key [25]. The TONES menu appears.

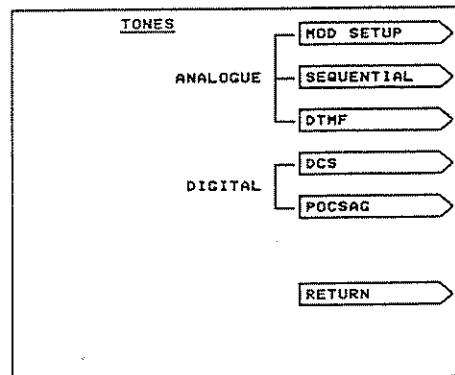

Fig. 3-16 TONES menu

Modulation setup

Under the TONES menu, press the MOD SETUP key. The RX MODULATION SETUP menu appears.

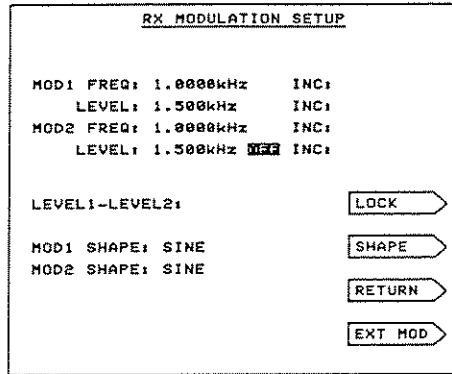

Fig. 3-17 RX MODULATION SETUP menu

This menu is an alternative display under which the modulation generator frequencies and levels can be set, both being shown together. In addition, the modulation generators can be enabled and disabled, the levels can be locked together and the waveforms can be selected.

To enable or disable the modulation generators, select the generator (as described under 'RF generator operation') and then use the ON OFF key **[1]** to select enabled or OFF. When both modulation generators are enabled, 2T (two tone) is shown on the display.

To lock the level of MOD2 so that it is the same as the level of MOD1, press the LOCK key to select LOCKED.

To change a waveform, select the modulation generator and then use the SHAPE key to select SINE, SQUARE, TRIANGLE or SAW TOOTH.

To control the external modulation, press the EXT MOD key. The EXTERNAL MOD INPUT frequency and level appear. To enable and disable the external modulation, use the key which is arrowed by EXT MOD and OFF alternately.

Pressing RETURN restores the RECEIVER TEST display.

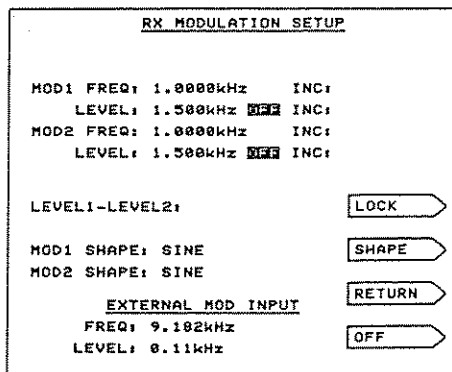

Fig. 3-18 RX MODULATION SETUP menu for external modulation

AF VOLTMETER

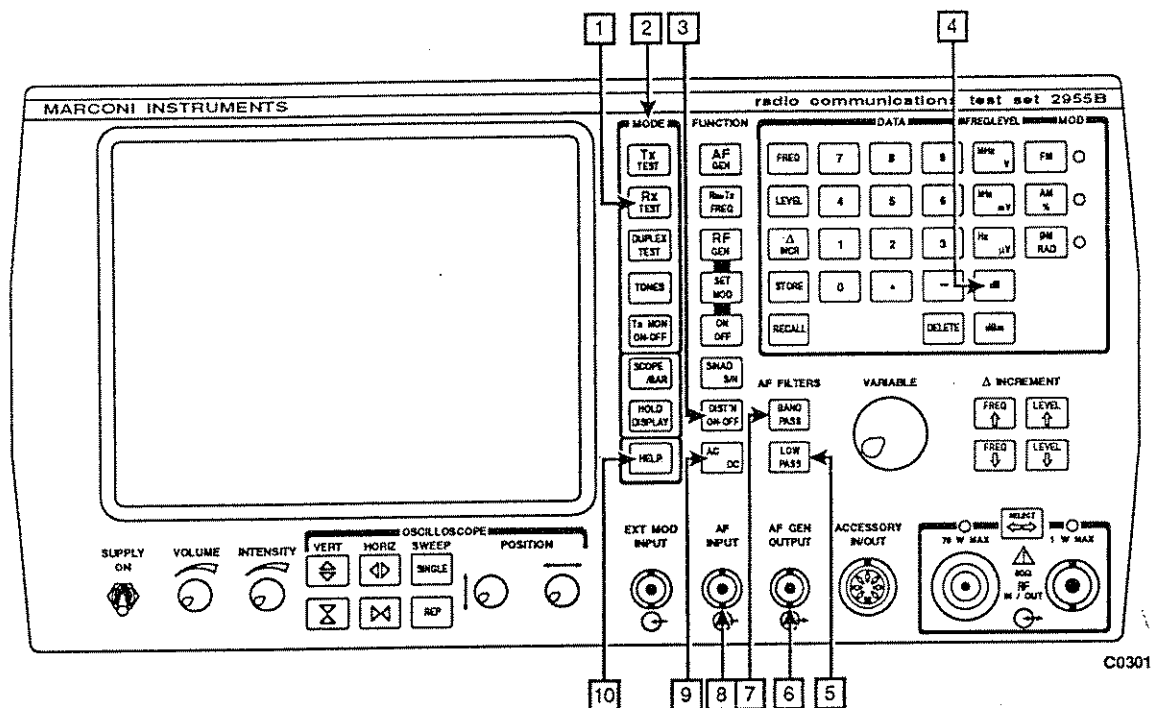

Fig. 3-19 AF voltmeter controls and connectors

AF voltmeter controls and connectors

- 1 **RX TEST key.** Used to select the RECEIVER TEST mode. Connects the AF voltmeter to the AF INPUT socket 8.
- 2 **MODE keys.** Used as soft keys to select programmed functions when menus are shown alongside on the screen.
- 3 **DIST'N ON-OFF key.** Set to OFF for dBV or dBr measurement.
- 4 **dB key.** Selects dBV or dBr.
- 5 **LOW PASS key.** Selects a 300 Hz or a 50 kHz low-pass filter.
- 6 **AF GEN OUTPUT socket.** BNC socket. Used for the optional 600 Ω dBm and 20 dB Attenuator accessory. See under 'Accessories' in Chap. 1.
- 7 **BAND PASS key.** Selects a 0.3 to 3.4 kHz band-pass filter.
- 8 **AF INPUT socket.** BNC socket. For the AF or modulated DC input. Impedance 1 M Ω .

- [9] AC DC key. Changes the state of the input from the socket [8] between an AF or a modulated DC voltage. The display indicates when AC or DC is selected.
- [10] HELP key. Enables access to the CHANGE PARAMETERS menu for selection of the 600 Ω Balanced Converter and 20 dB Attenuator.

AF voltmeter operation

- (1) Connect the unit under test to the AF INPUT socket [8] .
- (2) Select RX TEST [1] . The RECEIVER TEST display appears.

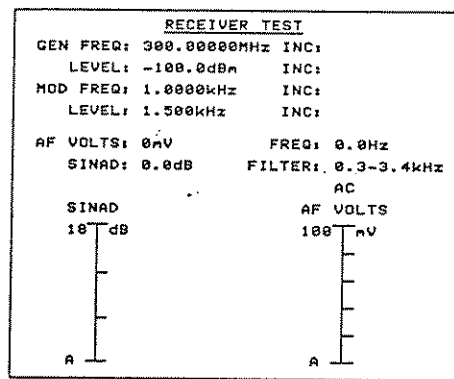

Fig. 3-20 RECEIVER TEST display

- (3) Press BAND PASS [7] to select the 0.3 to 3.4 kHz BP filter or press LOW PASS [5] once or twice as necessary to select a 300 Hz or 50 kHz LP filter.
- (4) To read AF volts, press the AC DC key [9] until AC is displayed.
- (5) To read DC plus AF volts, press the AC DC key [9] until DC is displayed. The 50 kHz filter is automatically selected. Note that the DC is shown with no sign but can be positive or negative.
- (6) To select dBV or dBr (dB relative to the entered level), set [3] to DIST'N OFF.
- (7) If required, change between dBV and dBr by pressing the dB key [4] .
- (8) To use the 600 Ω Interface Unit (e.g. for testing telephone lines), connect it to the AF GEN OUTPUT socket [6] and to the AF INPUT socket [8] . When DIST'N ON-OFF [3] is pressed once or twice (to switch off DISTN) there is an AF VOLTS reading on the RECEIVER TEST display in dBm or dBV. To change the unit, press the HELP key [10] , select the CHANGE PARAMETERS option and use the soft key for the 600 Ω BALANCED AF ACCESSORY. Select FITTED for dBm or NOT FITTED for dBV. With either setting, a reading in dBr can be obtained by pressing dB [4] and then pressing it again to return to dBm or dBV.

DISTORTION AND NOISE METER

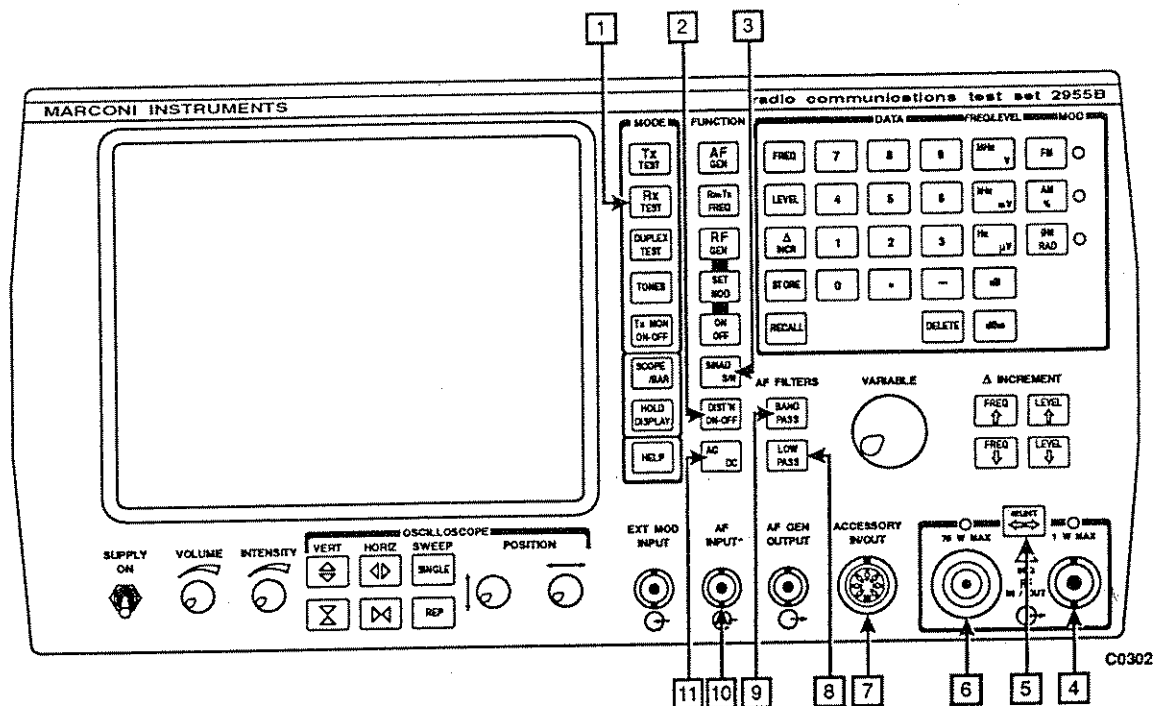

Fig. 3-21 Distortion and noise meter controls and connectors

Distortion and noise meter controls and connectors

- 1 **RX TEST** key. Used to select the RECEIVER TEST mode. Connects the RF generator output to RF IN/OUT BNC and N sockets 4 and 6 and connects the distortion meter to the AF INPUT socket 10.
- 2 **DIST'N ON-OFF** key. Causes the AF generator to modulate the RF generator with a 1 kHz tone.
- 3 **SINAD S/N** key. Selects SINAD or signal/noise. When SINAD is selected, causes the AF generator to modulate the RF generator with a 1 kHz tone. The display indicates when SINAD or S/N is selected.
- 4 **RF IN/OUT BNC** socket. For RF generator output levels up to 225 mV. Impedance 50 Ω .
- 5 **SELECT** key and LEDs. For selecting RF IN/OUT socket 4 or 6. LED lights above the socket selected.
- 6 **RF IN/OUT N** socket. For RF generator output levels up to 22.5 mV. Impedance 50 Ω .
- 7 **ACCESSORY** socket. DIN 7-pin connector for an external psophometric (telephone weighting) CCITT or C-message filter option.

LOCAL OPERATION

- 8 LOW PASS key. Selects a 300 Hz or a 50 kHz low-pass filter.
- 9 BAND PASS key. Selects a 0.3 to 3.4 kHz band-pass filter.
- 10 AF INPUT socket. BNC socket. For the AF input. Impedance 1 M Ω .
- 11 AC DC key. This key is disabled and AC automatically selected whenever DIST'N 2 or SINAD or S/N 3 is selected.

Distortion and noise meter operation

To make a receiver distortion measurement, proceed as follows:-

- (1) Select RX TEST 1 . The RECEIVER TEST display appears.
- (2) Set the RF generator to the frequency of the receiver under test (as under 'RF generator operation').
- (3) Connect the receiver's antenna input to either the BNC socket 4 or the N socket 6 .
- (4) Connect the receiver's audio output to the AF INPUT socket 10 .
- (5) Press the DIST'N ON-OFF key 2 until DISTN is displayed. AC coupling and the 0.3 to 3.4 kHz band-pass filter are automatically selected.

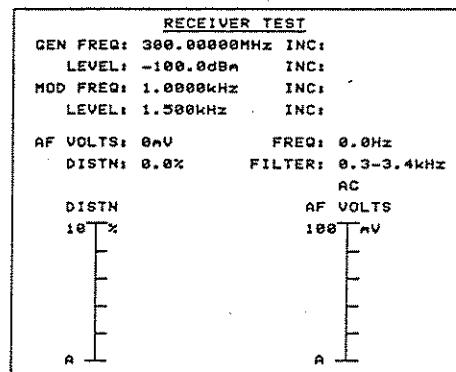

Fig. 3-22 RECEIVER TEST display

- (6) Press LOW PASS 8 once or twice as necessary to select a 300 Hz or 50 kHz LP filter. Press BAND PASS 9 to return to the 0.3 to 3.4 kHz BP filter.
- (7) Read the % distortion from the display.
- (8) If required, connect an external psophometric filter to the ACCESSORY socket 7 and the radio's audio output to the filter. Correct connection is denoted by the display showing either CCITT or C-MESS in place of any previously selected internal filter.

- (9) Press the SINAD S/N key 3 until SINAD is displayed. AC coupling and the 0.3 to 3.4 kHz band-pass filter are automatically selected.
- (10) Read the SINAD in dB from the display.
- (11) Press the SINAD S/N key 3 until S/N is displayed.
- (12) Read the S/N in dB from the display.
- (13) To return to normal operation, select DIST'N OFF using key 2 .

Duplex testing

CONTROLS AND CONNECTORS

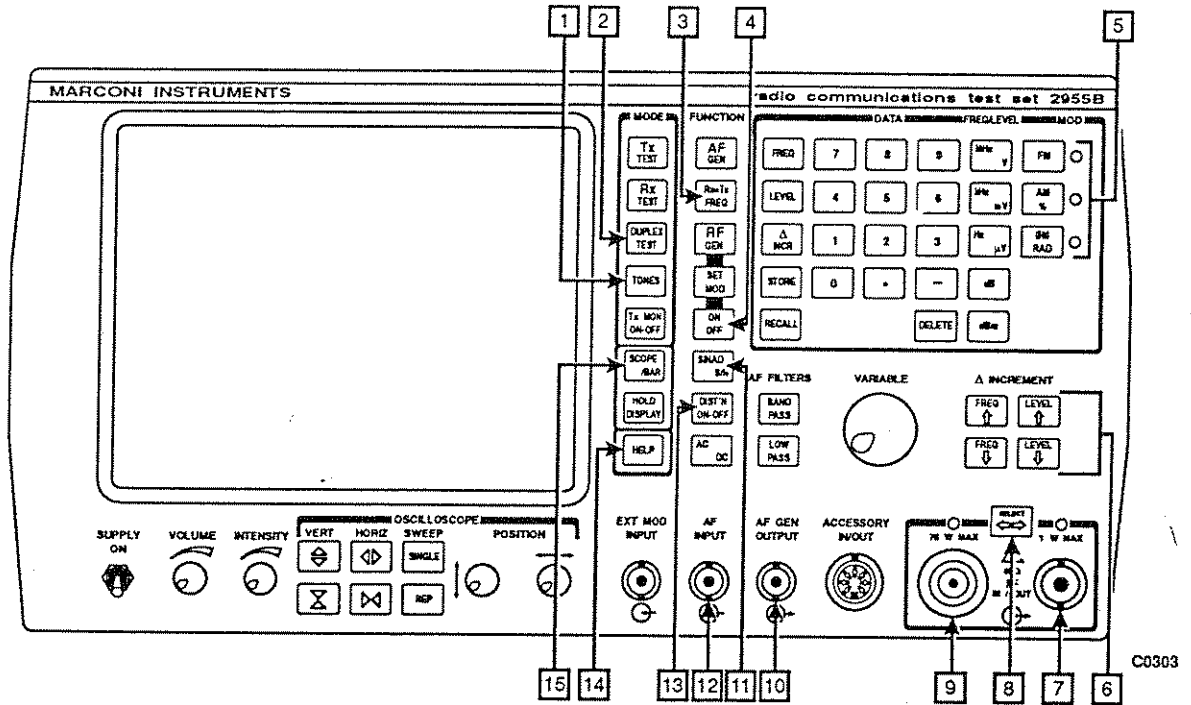

Fig. 3-23 Duplex testing controls and connectors

- 1 TONES key. Used to select the TONES menu.
- 2 DUPLEX TEST key. Used to select the DUPLEX test mode. Connects the RF generator to RF IN/OUT socket 7 or 9, the modulation meter and the power meter to socket 9 and the distortion meter to socket 12.
- 3 RX=TX FREQ key. Can be used to set the RF generator to the transmitter frequency. When there is an RX to TX frequency offset, it is followed by an increment key which has been preset to the appropriate offset.
- 4 ON OFF key. Enables and disables the modulation and AF generators.
- 5 MOD keys and LEDs. Enable the type of modulation to be entered. LED lights to show FM, AM or Φ M.
- 6 Δ INCREMENT keys. Only operable when the RF generator step value has previously been set in the RECEIVER TEST mode.
- 7 RF IN/OUT BNC socket. Connects the RF generator to the receiver input for two-port operation. Impedance 50 Ω .

- [8] **SELECT key.** Used to select one-port or two-port operation.
- [9] **RF IN/OUT N socket.** Connects the input from the transmitter for two-port operation or simultaneous input from the transmitter and output from the RF generator for one-port operation. A temperature sensor detects excessive power. Impedance 50 Ω .
- [10] **AF GEN OUTPUT socket.** BNC socket. For output for modulating the transmitter in deviation measurements.
- [11] **SINAD S/N key.** Selects SINAD or signal/noise. When SINAD is selected, causes the AF generator to modulate the RF generator with a 1 kHz tone. The display indicates when SINAD or S/N is selected.
- [12] **AF INPUT socket.** BNC socket. For the AF input for distortion or SINAD measurements. Impedance 1 M Ω .
- [13] **DIST'N ON-OFF key.** Causes the AF generator to modulate the RF generator with a 1 kHz tone.
- [14] **HELP key.** Enables access to the CHANGE PARAMETERS menu for selection of the RX/TX MOD TYPE LOCK option.
- [15] **SCOPE/BAR key.** Disabled as bar charts only are displayed in the DUPLEX test mode.

OPERATION

Proceed as follows:-

- (1) Press DUPLEX TEST [2]. The DUPLEX test display appears. The current instrument settings are shown under RECEIVER and TRANSMITTER headings.

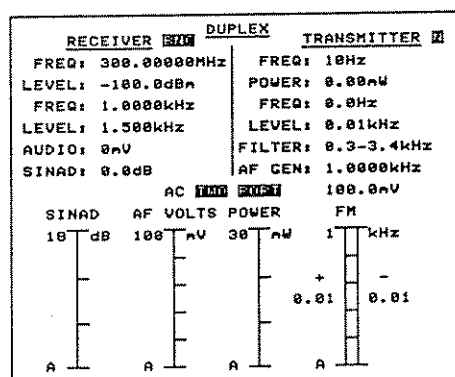

Fig. 3-24 DUPLEX test display

- (2) Select one-port operation by pressing the SELECT key [8] until ONE PORT is displayed in reverse video with the LED lit above socket [9].

LOCAL OPERATION

- (3) Select two-port operation by pressing the SELECT key [8] until TWO PORT is displayed in reverse video with both LEDs lit. Additionally, BNC and N are displayed in reverse video to indicate that the connections are the receiver to BNC socket [7] and the transmitter to N socket [9].
- (4) Set the receiver's frequency and set the RF generator frequency, level and modulation (as under these headings in 'RF generator operation'). However, the Δ INCREMENT keys [6] are only operable when the RF generator step value has been set previously in the RECEIVER TEST mode. The maximum RF generator output level is -21.5 dBm for one-port and -15 dBm for two-port operation. At levels above -80 dBm in one-port duplex mode, beware of break-through from the RF generator when using the modulation meter.
- (5) Connect the receiver input to either the N socket [9] for one-port operation or to the BNC socket [7] for two-port operation.
- (6) Set the transmitter's frequency, level and modulation. To set the type of modulation to be the same or not the same as the receiver's type of modulation, press the HELP key [14]. Then select the CHANGE PARAMETERS option. On PAGE 2 of the menu, select ON or OFF under the RX/TX MOD TYPE LOCK option. When the selection is OFF, use the MOD keys [5] to set the transmitter's type of modulation.
- (7) Connect the transmitter's output to the N socket [9] for both one-port and two-port duplex operation.
- (8) Read the transmitter's RF power and modulation parameters from the display. Note that, for the DUPLEX test mode, the bar chart display is required and therefore the SCOPE/BAR key [15] is disabled. Note also that the audio filter value is displayed under the TRANSMITTER side of the display but applies to both transmitter and receiver measurements.
- (9) Connect the AF GEN OUTPUT socket [10] to the transmitter's microphone input.
- (10) Connect the receiver's audio output to the AF INPUT socket [12].
- (11) Press DIST'N ON [13], SINAD or S/N [11] and read the receiver's distortion, SINAD or signal/noise ratio from the display.

TONES MENU

This gives access to the DUPLEX MOD AND AF SETUP menu as described below in addition to other options which are described under 'Signalling codes testing'.

In the DUPLEX test mode, press the TONES key **[1]**. The TONES menu appears.

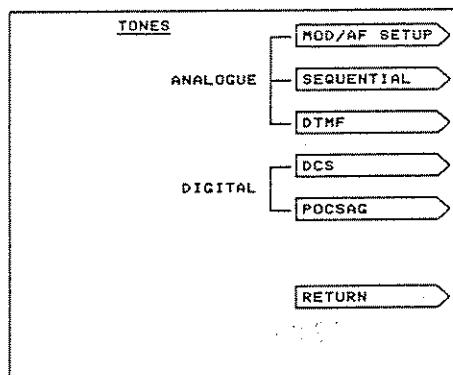

Fig. 3-25 TONES menu

MODULATION AND AF SETUP

Under the TONES menu, press the MOD/AF SETUP key. The DUPLEX MOD AND AF SETUP menu appears.

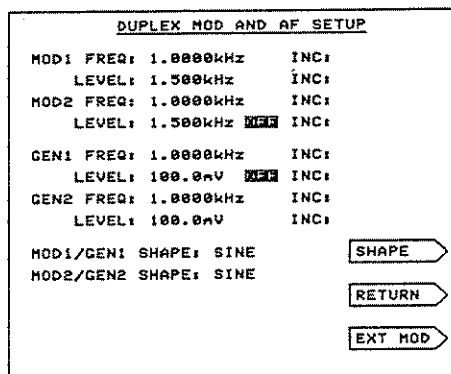

Fig. 3-26 DUPLEX MOD AND AF SETUP menu

This menu is an alternative display under which the modulation and AF generator frequencies and levels can be set, all being shown together. In addition, generators can be enabled and disabled and the waveforms can be selected.

To enable or disable the generators, select the generator and then use the ON OFF key **[4]** to select enabled or OFF. When both of the modulation or AF generators are enabled, 2T (two tone) is shown on the display.

To change a waveform, select the modulation generator and then use the SHAPE key to select SINE, SQUARE, TRIANGLE or SAW TOOTH.

LOCAL OPERATION

To control the external modulation, press the EXT MOD key. The EXTERNAL MOD INPUT frequency and level appear. These can be set as for the internal modulation. To enable and disable the external modulation, use the key which is arrowed by ON and OFF alternately.

DUPLEX MOD AND AF SETUP		
MOD1 FREQ:	1.0000kHz	INC:
LEVEL:	1.500kHz	OFF INC:
MOD2 FREQ:	1.0000kHz	INC:
LEVEL:	1.500kHz	OFF INC:
GEN1 FREQ:	1.0000kHz	INC:
LEVEL:	100.0nV	OFF INC:
GEN2 FREQ:	1.0000kHz	INC:
LEVEL:	100.0nV	INC:
MOD1/GEN1 SHAPE:	SINE	SHAPE
MOD2/GEN2 SHAPE:	SINE	RETURN
EXTERNAL MOD INPUT		
FREQ:	0.0Hz	OFF
LEVEL:	0kHz	

Fig. 3-27 DUPLEX MOD AND AF SETUP menu for external modulation

For using the 600 Ω Interface Unit or a 20 dB Attenuator, see under 'AF generator operation'. LEVEL settings unit, reduction of the displayed LEVEL and A in reverse video are as on the TRANSMITTER TEST display.

Pressing RETURN restores the DUPLEX test display.

Audio testing

AF GENERATORS

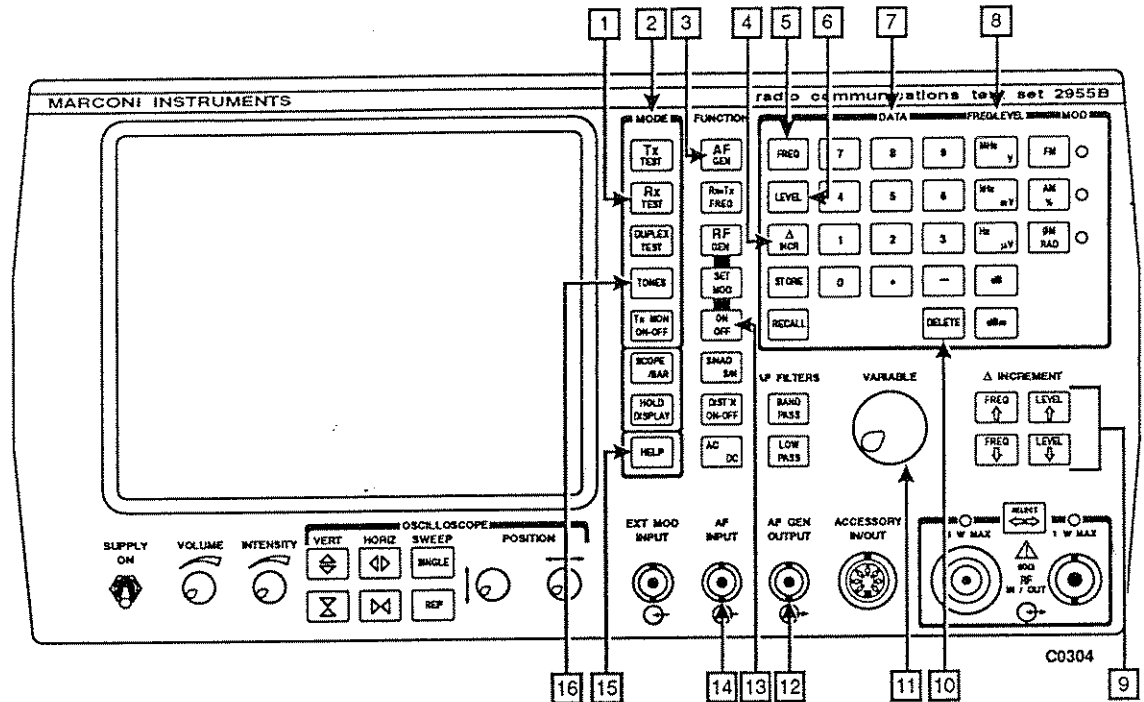

Fig. 3-28 AF generator controls and connectors

AF generator controls and connectors

- 1 RX TEST key. Used with 3 to select the AUDIO TEST mode.
- 2 MODE keys. Used as soft keys to select programmed functions when menus are shown alongside on the screen.
- 3 AF GEN key. Used with 1 to select the AUDIO TEST mode.
- 4 Δ INCR key. Follows a FREQ 5 or LEVEL 6 entry so that the entered data is recognized as an increment or decrement.
- 5 FREQ key. Precedes a keypad 7 entry so that the entered data is recognized as a frequency.
- 6 LEVEL key. Precedes a keypad 7 entry so that the entered data is recognized as a level.
- 7 DATA keypad. For data entry using numerals 0 to 9, decimal point and minus sign.
- 8 FREQ/LEVEL keys. For defining units of frequency or level. One of these terminates the data entry.

LOCAL OPERATION

- 9 Δ INCREMENT keys. Increase and decrease the frequency and the level by the increments which have been set using 4 .
- 10 DELETE key. Deletes a preceding digit, decimal point or minus sign which has been entered on the keypad 7 .
- 11 VARIABLE control. Analogue control which varies the smallest increment of the function data. Step size is independent of 4 and depends upon range. The level or frequency assignment is shown in reverse video on the screen.
- 12 AF GEN OUTPUT socket. BNC socket. Supplies one or two outputs in the range 10 Hz to 20 kHz for single-tone or two-tone operation. Impedance $<5 \Omega$.
- 13 ON OFF key. Enables and disables the AF generators.
- 14 AF INPUT socket. BNC socket. For the audio input. Impedance $1 M\Omega$.
- 15 HELP key. Enables access to the CHANGE PARAMETERS menu for selection of the 600Ω Balanced Converter and 20 dB Attenuator.
- 16 TONES key. Used to select the TONES menu.

AF generator operation

AF generator operation consists of initial actions (1) to (4) and then, for one or both of the two AF generators, AF frequency setting (5) to (7) and level setting (8) to (11) as follows:-

- (1) Select RX TEST 1 . The RECEIVER TEST display appears.
- (2) Press AF GEN 3 . This selects the AUDIO TEST mode and the first AF generator. GEN1 is shown in reverse video on the screen. To select the second AF generator, press AF GEN 3 followed by 2 on the keypad 7 . After this, use AF GEN 3 followed by 1 on the keypad 7 when you require to go back to the first AF generator. Initially, the first AF generator is enabled and the second is OFF, as shown on the display. To enable and disable the generators, see later under 'Audio setup'.

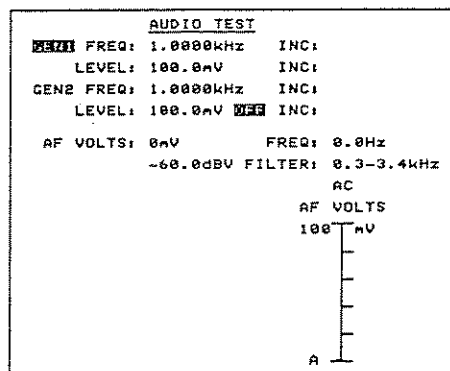

Fig. 3-29 AUDIO TEST display

- (3) Connect the unit under test to the AF GEN OUTPUT socket **12** .
- (4) To use the 600 Ω Interface Unit (e.g. for testing telephone lines), connect it to the AF GEN OUTPUT socket **12** and to the AF INPUT socket **14** . The GEN LEVEL settings on the AUDIO TEST display are shown in dBm or V. To change the unit, press the HELP key **15** , select the CHANGE PARAMETERS option and use the soft key for the 600 Ω BALANCED AF ACCESSORY. Select FITTED for dBm. LEVEL settings can then be entered in dBm or V. When the instrument is switched off and then on again, any V setting is converted to dBm. Select NOT FITTED for V. LEVEL settings can then be entered in V only.
- (5) Select FREQ **5** . The frequency to be changed is shown in reverse video. Enter the data on the keypad **7** , ending with the frequency terminator **8** . To enter 1.235 kHz, use the following:-



If a mistake is made during data entry, press DELETE **10** and then enter the correct character. When, however, the terminator **8** has been pressed, re-enter the complete data. If incorrect data has been entered (e.g. a frequency outside the range of the instrument), the terminator is ignored and the entry is not accepted. Use DELETE and then re-enter the data.

- (6) If required, set the frequency increment/decrement by selecting Δ INCR **4** and entering the data, ending with the frequency terminator. To enter 500 Hz steps, use the following:-



In the example, FREQ can be omitted since it has been previously entered in (5).

- (7) Having set the step size, the frequency can be adjusted by repeatedly pressing one of the Δ INCREMENT keys **9** , FREQ \uparrow for an increment or FREQ \downarrow for a decrement. For fine frequency control, use the VARIABLE control **11** .
- (8) Select LEVEL **6** . The level to be changed is displayed in reverse video. Enter the data on the keypad **7** , ending with the level terminator **8** . To enter 50 mV, use the following:-



- (9) If required, set the level increment/decrement by selecting Δ INCR **4** and entering the data, ending with the level terminator. To enter 200 mV steps, use the following:-

In the example, LEVEL can be omitted since it has been previously entered in



(8).

- (10) Having set the step size, the level can be adjusted by repeatedly pressing one of the Δ INCREMENT keys **[9]**, LEVEL \uparrow for an increment or LEVEL \downarrow for a decrement. For fine level control, use the VARIABLE control **[11]**.
- (11) To use the 20 dB Attenuator, connect it to the AF GEN OUTPUT socket **[12]**. To reduce the displayed AF GEN LEVEL, press the HELP key **[15]**, select the CHANGE PARAMETERS option and use the soft key for the 20 dB ATTENUATOR ACCESSORY. Select FITTED for a reduction of 20 dB or NOT FITTED for the actual level at the socket. When FITTED has been selected, A in reverse video is displayed alongside the FREQ setting.

TONES menu

This gives access to the AUDIO SETUP menu as described below in addition to other options which are described under 'Signalling codes testing'.

In the AUDIO TEST mode, press the TONES key **[15]**. The TONES menu appears.

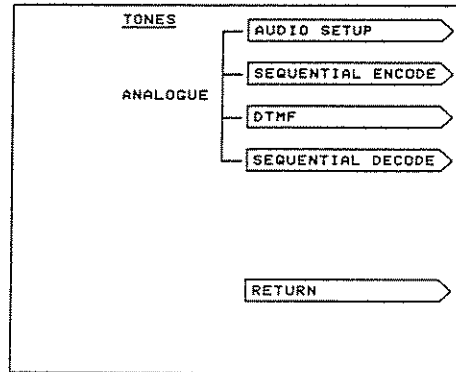

Fig. 3-30 TONES menu

Audio setup

Under the TONES menu, press the AUDIO SETUP key. The AUDIO SETUP menu appears.

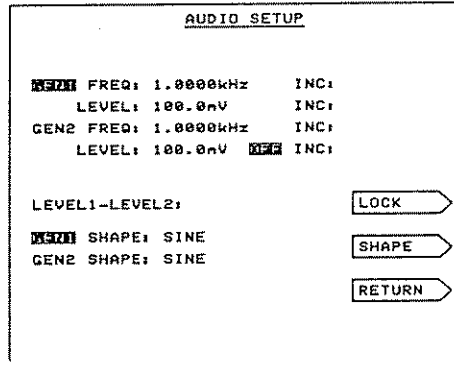

Fig. 3-31 AUDIO SETUP menu

This menu is an alternative display under which the AF generator frequencies and levels can be set, both being shown together. In addition, the AF generators can be enabled and disabled, the levels can be locked together and the waveforms can be selected.

To enable or disable the AF generators, select the generator (as described under 'AF generator operation') and then use the ON OFF key **13** to select enabled or OFF. When both AF generators are enabled, 2T (two tone) is shown on the display.

To lock the level of GEN2 so that it is the same as the level of GEN1, press the LOCK key to select LOCKED.

To change a waveform, select the AF generator and then use the SHAPE key to select SINE, SQUARE, TRIANGLE or SAW TOOTH.

For using the 600 Ω Interface Unit or a 20 dB Attenuator, see under 'AF generator operation'. LEVEL settings unit, reduction of the displayed LEVEL and A in reverse video are as on the AUDIO TEST display.

Pressing RETURN restores the AUDIO TEST display.

AF VOLTMETER

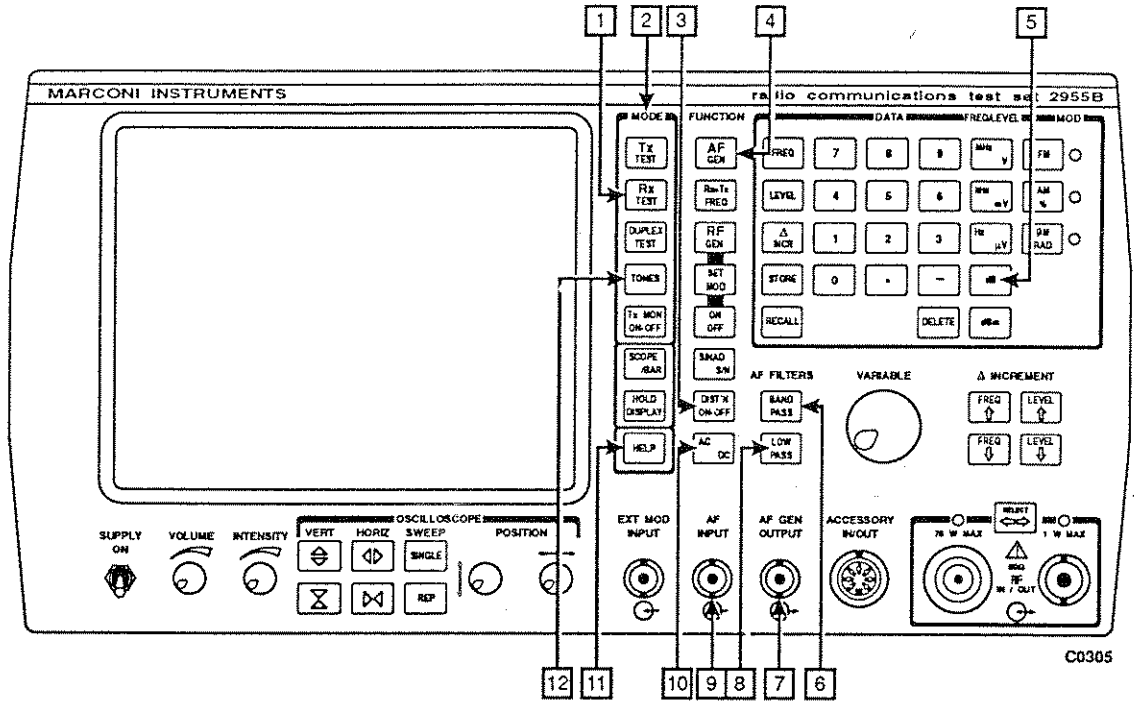

Fig. 3-32 AF voltmeter controls and connectors

AF voltmeter controls and connectors

- 1 RX TEST key. Used with 4 to select the AUDIO TEST mode.
- 2 MODE keys. Used as soft keys to select programmed functions when menus are shown alongside on the screen.
- 3 DIST'N ON-OFF key. Set to OFF for dBV or dBr measurement.
- 4 AF GEN key. Used with 1 to select the AUDIO TEST mode.
- 5 dB key. Selects dBV or dBr.
- 6 BAND PASS key. Selects a 0.3 to 3.4 kHz band-pass filter.
- 7 AF GEN OUTPUT socket. BNC socket. Used for the optional 600 Ω dBm and 20 dB Attenuator accessory. See under 'Accessories' in Chap. 1.
- 8 LOW PASS key. Selects a 300 Hz or a 50 kHz low-pass filter.
- 9 AF INPUT socket. BNC socket. For the AF or modulated DC input. Impedance 1 M Ω .
- 10 AC DC key. Changes the state of the input from the socket 9 between an AF or a modulated DC voltage. The display indicates when AC or DC is selected.

- 11 HELP key. Enables access to the CHANGE PARAMETERS menu for selection of the 600 Ω Balanced Converter and 20 dB Attenuator.
- 12 TONES key. Used to select the TONES menu.

AF voltmeter operation

In the AUDIO TEST mode, AF generator operation is enabled in addition to the AF voltmeter. This permits the AF generators to be tuned while the voltmeter readings are noted. This can be used to plot the characteristics of a filter or an amplifier which is connected between the AF GEN OUTPUT and the AF INPUT sockets. Proceed as follows:-

- (1) Connect the unit under test to the AF INPUT socket 9 .
- (2) Select RX TEST 1 . The RECEIVER TEST display appears.
- (3) Press AF GEN 4 . The AUDIO TEST display appears.

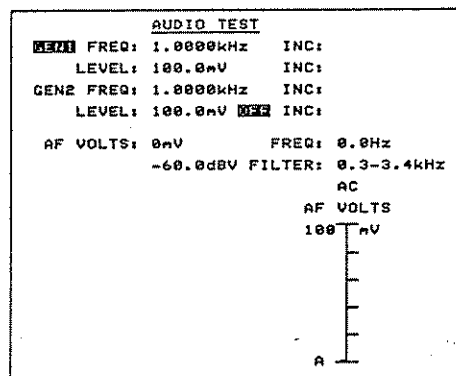

Fig. 3-33 AUDIO TEST display

- (4) Press BAND PASS 6 to select the 0.3 to 3.4 kHz filter or press LOW PASS 8 once or twice as necessary to select a 300 Hz or 50 kHz filter.
- (5) To read AF volts, press the AC DC key 10 until AC is displayed.
- (6) To read DC plus AF volts, press the AC DC key 10 until DC is displayed. The 50 kHz filter is automatically selected. Note that the DC is shown with no sign but can be positive or negative.
- (7) To select dBV or dBr (dB relative to the entered level), set 3 to DIST'N OFF.
- (8) If required, change between dBV and dBr by pressing the dB key 5 .

- (9) To use the 600 Ω Interface Unit (e.g. for testing telephone lines), connect it to the AF GEN OUTPUT socket [7] and to the AF INPUT socket [9]. There is an AF VOLTS reading on the AUDIO TEST display in dBm or dBV. To change the unit, press the HELP key [11], select the CHANGE PARAMETERS option and use the soft key for the 600 Ω BALANCED AF ACCESSORY. Selecty FITTED for dBm or NOT FITTED for dBV. With either setting, a reading in dBr can be obtained by pressing dB [5] and then pressing it again to return to dBm or dBV.

DISTORTION METER

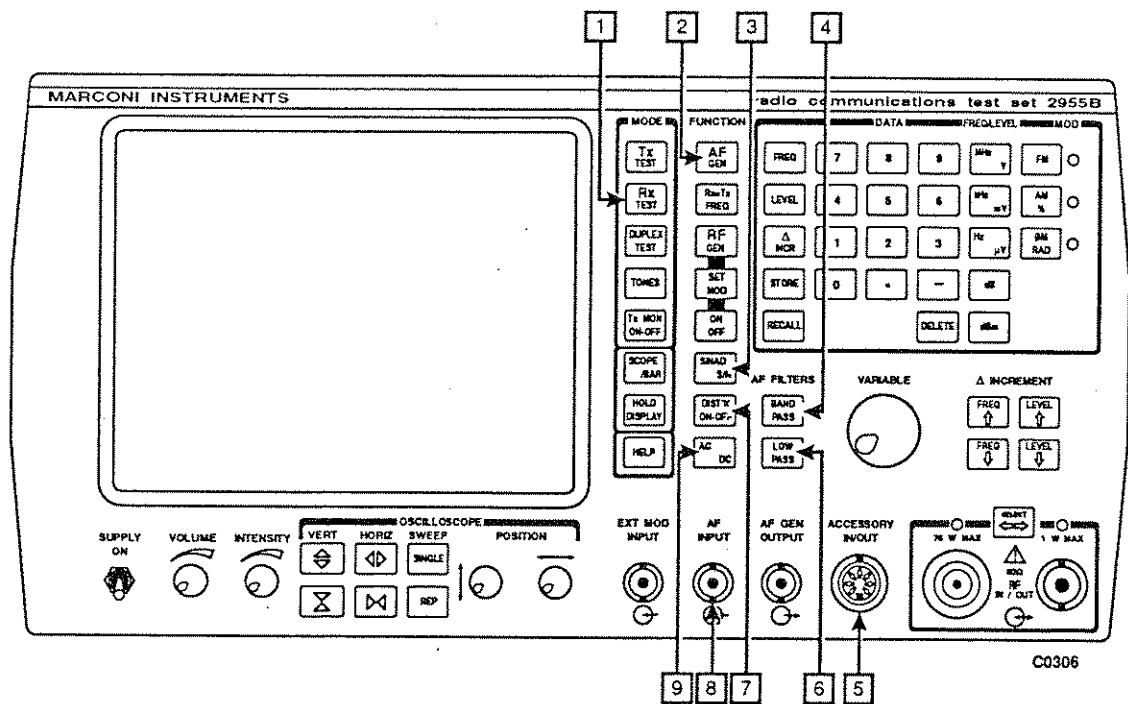

Fig. 3-34 Distortion meter controls and connectors

Distortion meter controls and connectors

- [1] RX TEST key. Used with [2] to select the AUDIO TEST mode.
- [2] AF GEN key. Used with [1] to select the AUDIO TEST mode.
- [3] SINAD S/N key. This key is inoperative.
- [4] BAND PASS key. Selects a 0.3 to 3.4 kHz band-pass filter.
- [5] ACCESSORY socket. DIN 7-pin connector for an external psophometric (telephone weighting) CCITT or C-message filter option.

- [6] LOW PASS key. Selects a 300 Hz or a 50 kHz low-pass filter.
- [7] DIST'N ON-OFF key. Causes the AF generator to modulate the RF generator with a 1 kHz tone.
- [8] AF INPUT socket. BNC socket. For the AF input. Impedance 1 M Ω .
- [9] AC DC key. This key is inoperative. AC is automatically selected whenever DIST'N [7] or SINAD or S/N [3] is selected.

Distortion meter operation

In the AUDIO TEST mode, AF generator is enabled in addition to the distortion meter. This enables an AF generator to supply the signal for distortion measurements (e.g. to test an audio amplifier which is connected between the AF GEN OUTPUT and the AF INPUT sockets). Proceed as follows:-

- (1) Connect the unit under test to the AF INPUT socket [8].
- (2) Select RX TEST [1]. The RECEIVER TEST display appears.
- (3) Press AF GEN [2]. The AUDIO TEST display appears.

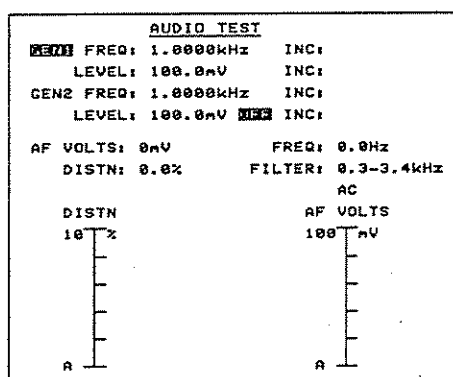

Fig. 3-35 AUDIO TEST display

- (4) Press the DIST'N ON-OFF key [7] until DISTN is displayed. AC coupling and the 0.3 to 3.4 kHz band-pass filter are automatically selected.
- (5) Press LOW PASS [6] once or twice as necessary to select a 300 Hz or 50 kHz LP filter. Press BAND PASS [4] to return to the 0.3 to 3.4 kHz filter.
- (6) Read the % distortion from the display.
- (7) If required, connect an external psophometric filter to the ACCESSORY socket [5] and the audio output to the filter.
- (8) To return to normal operation, select DIST'N OFF using key [7].

Signalling codes testing

CONTROLS AND CONNECTORS

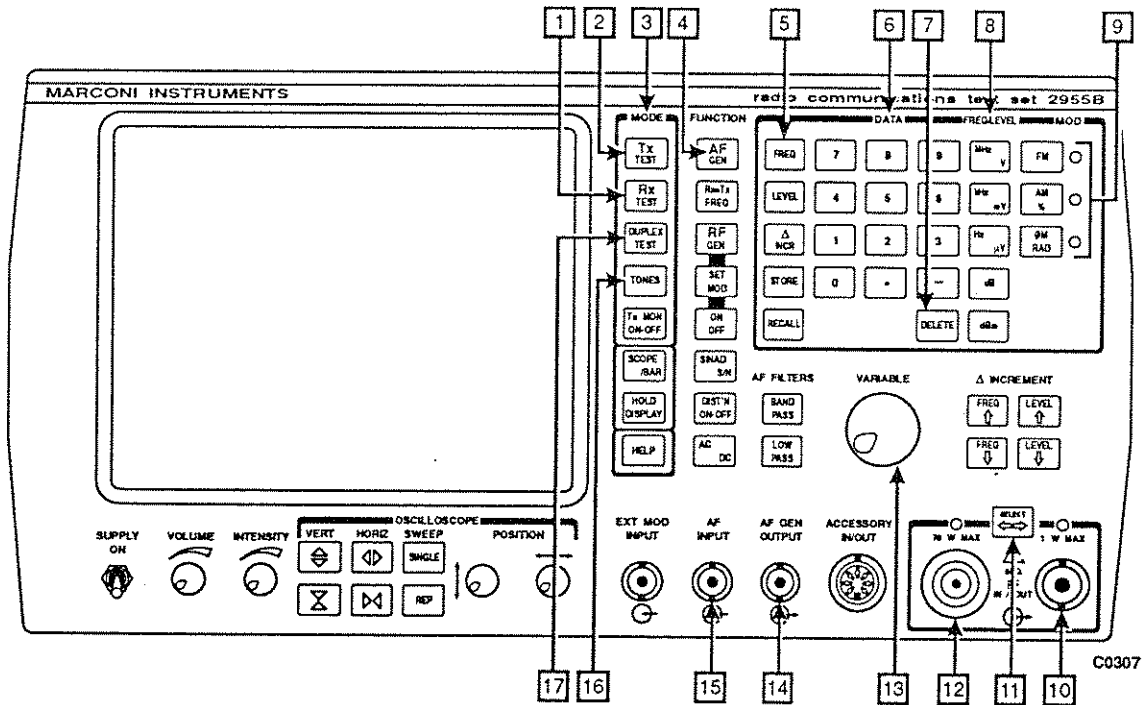

Fig. 3-36 Controls and connectors for signalling codes testing

- 1 RX TEST key. Used to select the RECEIVER TEST mode. Connects the RF generator output to RF IN/OUT sockets 10 and 12.
- 2 TX TEST key. Used to select the TRANSMITTER TEST mode. Connects the modulation meter to sockets 10 and 12.
- 3 MODE keys. These are used as soft keys to select programmed functions from menus which are shown alongside on the screen.
- 4 AF GEN key. Used with 1 to select the AUDIO TEST mode.
- 5 FREQ key. Precedes a keypad 6 entry so that the entered data is recognized as a frequency.
- 6 DATA keypad. For data entry using numerals 0 to 9, decimal point and minus sign.
- 7 DELETE key. Deletes a preceding digit, decimal point or minus sign which has been entered on the keypad 6.
- 8 FREQ/LEVEL keys. For defining units for frequency or level. Terminates the data entry.

- 9** MOD keys and LEDs. Enable the type of modulation to be entered. LED lights to show FM, AM or Φ M.
- 10** RF IN/OUT BNC socket. For the RF generator output for two-port duplex operation. Impedance 50 Ω .
- 11** SELECT key and LEDs. For selecting the RF IN/OUT BNC socket **10** or N socket **12**.
- 12** RF IN/OUT N socket. For tones simplex or one-port duplex operation. A temperature sensor detects excessive power being applied. Impedance 50 Ω .
- 13** VARIABLE control. Analogue control which provides an alternative to **5** for entering data.
- 14** AF GEN OUTPUT socket. BNC socket. Supplies one or two outputs in the range 10 Hz to 20 kHz for single-tone modulation or two-tone modulation. Impedance <5 Ω .
- 15** AF INPUT socket. BNC socket. For the audio input. Impedance 1 M Ω .
- 16** TONES key. According to the test mode, causes one of the TONES menus to be displayed.
- 17** DUPLEX TEST key. Used to select the DUPLEX test mode. Connects the RF generator to sockets **10** and **12**.

SEQUENTIAL TONES OPERATION

Transmitter testing

The tones decoder accepts up to 33 successive tones, 11 on each of 3 pages, including inter-tone pauses. Press the NEXT PAGE key to access the next or the first page. The frequency range is 0.3 to 3.4 kHz, the duration is 20 ms to 1.2 s and the inter-tone pauses are up to 800 ms.

To receive a programmed tones sequence, proceed as follows:-

- (1) Select TX TEST 2 . The TRANSMITTER TEST display appears.
- (2) Connect the output of the unit under test to either the RF IN/OUT BNC socket 10 or N socket 12 . Press SELECT 11 until the LED lights above the selected socket.
- (3) Key up the transmitter and ensure that the instrument is correctly tuned to the transmitter's frequency.
- (4) Select TONES 16 . The TONES menu appears.

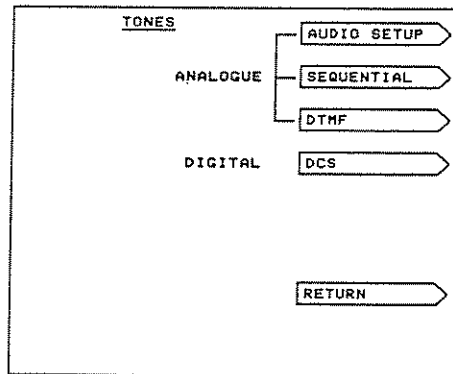

Fig. 3-37 TONES menu

- (5) From the TONES menu, select SEQUENTIAL. The SEQUENTIAL TONES menu appears.

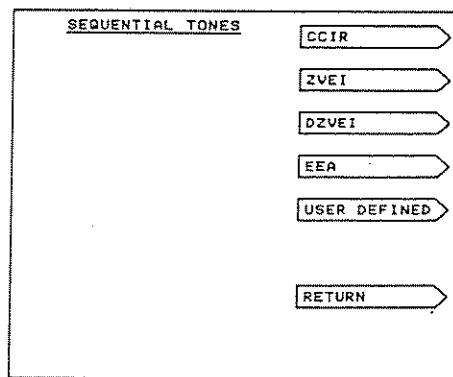

Fig. 3-38 SEQUENTIAL TONES menus

- (6) To return to the TRANSMITTER TEST display at any time, press the key which is arrowed by RETURN.
- (7) From the options on the SEQUENTIAL TONES menu, select the required frequency standard as shown in Table 3-1. As supplied, each 2955B is programmed either for EEA (European) or for EIA (North American) standards. EEA or EIA is shown on the display. To change this standard, see under 'TONE STANDARD selection'. Use the MODE key 3 which is arrowed by the frequency standard (e.g. CCIR). The appropriate TX SEQUENTIAL TONES display appears (e.g. CCIR).

TABLE 3-1 SEQUENTIAL TONES STANDARDS

Tone number	Frequency				
	CCIR Hz	ZVEI Hz	DZVEI Hz	EIA Hz	EEA Hz
0	1981	2400	2200	600	1981
1	1124.6	1060.6	970	741	1124
2	1197	1160	1060.6	882.5	1197
3	1275	1270	1160	1023	1275
4	1358	1400	1270	1164	1358
5	1446	1530	1400	1305	1446
6	1540	1670	1530	1446	1540
7	1640	1830	1670	1587	1640
8	1747	2000	1830	1728	1747
9	1860	2200	2000	1869	1860
10	2400	2800	2400	459	1055
11	930	810	2600	1000	930
12	2247	970	885	1000	2247
13	991	885	825	1000	991
14	2110	2600	810	1000	2110
Duration	100 ms	70 ms	70 ms	33 ms	40 ms
Extended	700 ms	700 ms	700 ms	330 ms	400 ms

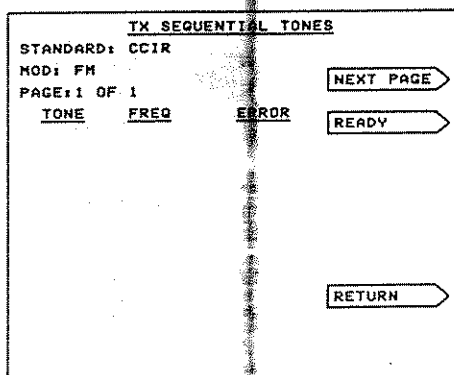

Fig. 3-39 TX SEQUENTIAL TONES display for CCIR

LOCAL OPERATION

- (8) On the transmitter triggered, the
- (9) At the end of a number, frequency, the error. If the error number.
- (10) For another test READY. Other RETURN.

activate the tones which are to be measured. When the instrument displays ACTIVE.

After measurement, ACTIVE is removed and the received tone standard % error are displayed. If it is within 5% of a standard tone number is displayed along with the associated error. If it is worse than 2%, an asterisk is displayed next to the tone

press the key which is arrowed by RESET. This changes to TRANSMITTER TEST display by pressing

User-defined standard

For the user to define

STANDARD

standard (for all modes), proceed as follows:-

- (1) Select TONES options on the USER DEFINED frequencies a

From the TONES menu, select SEQUENTIAL. From the SEQUENTIAL TONES menu, select USER DEFINED. The USER DEFINED STANDARD display appears with the current tone numbers, frequencies and information.

TONE	FREQ	USER DEFINED STANDARD
1	1.0000kHz	ENTER FREQ USING
2	1.1000kHz	DATA KEYS
3	73.6Hz	NEXT TONE
4	1.3000kHz	
5	1.4000kHz	ENTER TONE DURATION
6	66.4Hz	IN MS
7	1.6000kHz	DURATION: 20ms
8	1.7000kHz	MS
9	59.2Hz	
0	1.9000kHz	CONTINUE
1	2.0000kHz	
2	52.0Hz	RETURN
3	2.2000kHz	
4	2.3000kHz	COPY
5	70.4Hz	

Fig. 3-9

Typical USER DEFINED STANDARD display

- (2) When a frequency change is required, press the key which is arrowed NEXT TONE. Any frequency between 20 Hz and 20 kHz can be assigned. Increment sizes for the tone frequencies are 0.1 Hz from 20 Hz to 3.277 kHz and 1 Hz from 3.277 kHz to 20 kHz. This user-defined data is stored in non-volatile memory.
- (3) Enter the frequency using the keypad [6], ending with the FREQ/LEVEL key. This moves the cursor down ready for the next entry.
- (4) Repeat (2) and (3) as necessary.
- (5) Set the TONE DURATION by pressing the DURATION soft key and then entering the duration in ms using the DATA keypad [8]. Terminate by pressing the RETURN key.

When a frequency change is required, press the key which is arrowed NEXT TONE. Any frequency between 20 Hz and 20 kHz can be assigned. Increment sizes for the tone frequencies are 0.1 Hz from 20 Hz to 3.277 kHz and 1 Hz from 3.277 kHz to 20 kHz. This user-defined data is stored in non-volatile memory.

Enter the frequency using the keypad [6], ending with the FREQ/LEVEL key. This moves the cursor down ready for the next entry.

Repeat (2) and (3) as necessary.

Set the TONE DURATION by pressing the DURATION soft key and then entering the duration in ms using the DATA keypad [8]. Terminate by pressing the RETURN key.

- (6) A frequency standard can be used as the basis for a user-defined standard. Press the COPY soft key. The COPY TONES MENU appears.

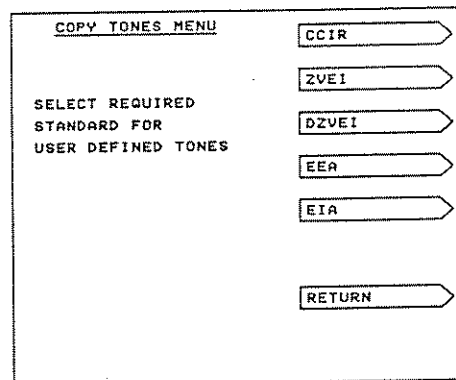

Fig. 3-41 COPY TONES MENU

- (7) From the options on the COPY TONES MENU, select the required frequency standard. The USER DEFINED STANDARD display appears with the appropriate tone numbers, frequencies and duration. These can then be changed as described above.
- (8) Press the CONTINUE soft key to return to the SEQUENTIAL TONES menu.
- (9) Press the RETURN soft key to return to the previous mode.

Receiver testing

To generate a programmed tones sequence in the RECEIVER TEST mode, proceed as follows:-

- (1) Select RX TEST **[1]**. The RECEIVER TEST display appears.
- (2) Connect the input of the unit under test to either the RF IN/OUT BNC socket **[10]** or N socket **[12]**. Press SELECT **[11]** until the LED lights above the selected socket.
- (3) Select TONES **[16]**. The TONES menu appears.

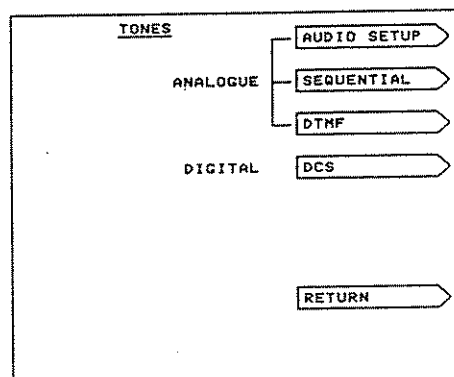

Fig. 3-42 TONES MENU

- (4) From the TONES menu, select SEQUENTIAL. The SEQUENTIAL TONES menu appears.

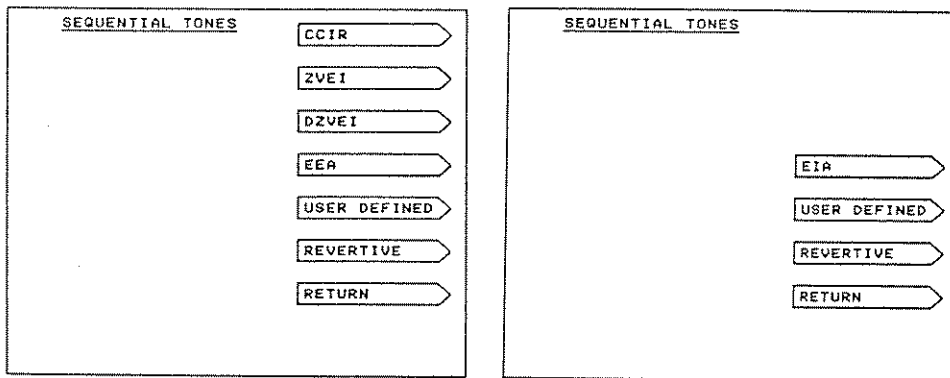

Fig. 3-43 SEQUENTIAL TONES menus

- (5) To return to the RECEIVER TEST display at any time, press the key which is arrowed by RETURN.
- (6) From the options on the SEQUENTIAL TONES menu, select the required frequency standard as described under 'Transmitter test' (e.g. CCIR). The appropriate RX SEQUENTIAL TONES display appears.

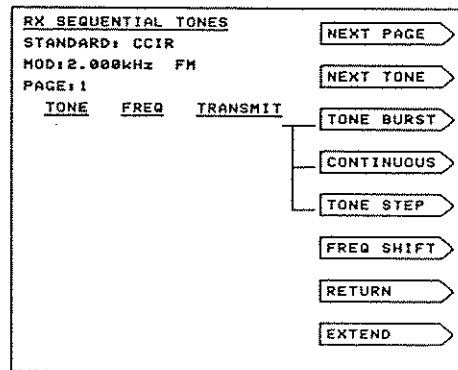

Fig. 3-44 RX SEQUENTIAL TONES display for CCIR

- (7) On PAGE 1, enter up to 11 tones by pressing the NEXT TONE key and then the tone number using the keypad [6]. To terminate each entry, press NEXT TONE again. This causes the frequency to be displayed against the entered tone number and moves the cursor down ready for the next entry.
- (8) To select PAGE 2 and then PAGE 3, press the NEXT PAGE key. A further 11 tones can be entered on each of these pages.
- (9) To create an inter-tone pause, press the key which is arrowed by NEXT TONE without entering a tone number. Repeat for multiples of the tone duration. Then, when the next tone number is entered, NULLs are displayed. A pause can be created in place of an entered frequency by moving the cursor appropriately and then pressing DELETE [7].

- (10) To select an extended tone (of 10 times the tone duration up to 700 ms unless user-defined), press the key which is arrowed by EXTEND. This facility is used for scanning receivers to ensure capture of the first tone. The letter E is displayed alongside the altered tone frequency. The EXTEND arrow changes to CANCEL E. Press this key to revert to normal tones operation.
- (11) To generate the tones sequence, press the key which is arrowed by TONE STEP, TONE BURST or CONTINUOUS as required. The CONTINUOUS arrow changes to TONES STOP to enable the continuous operation to be interrupted.
- (12) If required, select a frequency offset in the range $\pm 9\%$ by pressing the key which is arrowed by FREQ SHIFT. Enter the offset using one of the keys 0 to 9 with a minus sign when appropriate. All the previously selected tone frequencies are reset and displayed.
- (13) To return to the RECEIVER TEST display, press the key which is arrowed by RETURN. If CONTINUOUS has been selected, the tones continue to be transmitted.

Duplex testing

To generate a programmed tone sequence in the DUPLEX test mode, follow the instructions for interconnections and general operating procedures given under 'Duplex testing'. Then, continue from (4) under 'Receiver testing'.

Tones cannot be received in the DUPLEX test mode. To test the reception of a sequential tones sequence, leave the DUPLEX test mode and follow the instructions given under 'Transmitter testing'.

Audio testing

To generate a programmed tones sequence in the AUDIO TEST mode, proceed as follows:-

- (1) Select RX TEST 1 and AF GEN 4 . The AUDIO TEST display appears.
- (2) Connect the input of the unit under test to the AF GEN OUTPUT socket 14 .
- (3) Select TONES 16 . The TONES menu appears.

LOCAL OPERATION

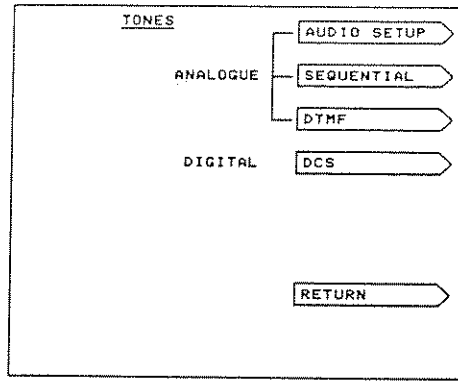

Fig. 3-45 TONES menu

- (4) From the TONES menu, select SEQUENTIAL ENCODE. The SEQUENTIAL TONES menu appears.

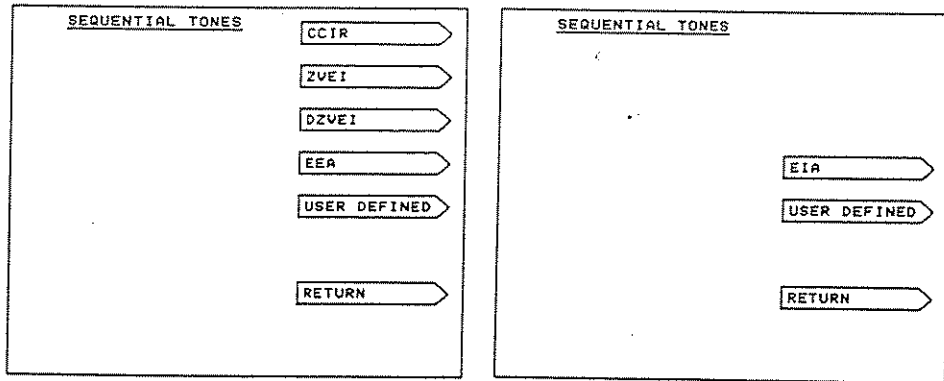

Fig. 3-46 SEQUENTIAL TONES menus

- (5) To return to the AUDIO TEST display at any time, press the key which is arrowed by RETURN.
- (6) From the options on the SEQUENTIAL TONES menu, select the required frequency standard as described under 'Transmitter testing' (e.g. CCIR). The appropriate AF SEQUENTIAL TONES display appears.

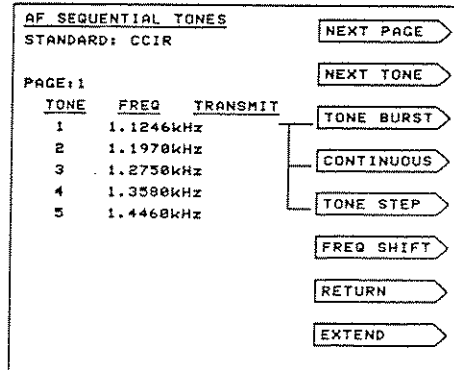

Fig. 3-47 AF SEQUENTIAL TONES display for generating CCIR

- (7) On PAGE 1, enter up to 11 tones by pressing the NEXT TONE key and then the tone number using the keypad **[6]** . To terminate each entry, press NEXT TONE again. This causes the frequency to be displayed against the entered tone number and moves the cursor down ready for the next entry.
- (8) To select PAGE 2 and then PAGE 3, press the NEXT PAGE key. A further 11 tones can be entered on each of these pages.
- (9) To create an inter-tone pause, press the key which is arrowed by NEXT TONE without entering a tone number. Repeat for multiples of the tone duration. Then, when the next tone number is entered, NULLs are displayed. A pause can be created in place of an entered frequency by moving the cursor appropriately and then pressing DELETE **[7]** .
- (10) To select an extended tone (of 10 times the tone duration up to 700 ms unless user-defined), press the key which is arrowed by EXTEND. This facility is used for scanning receivers to ensure capture of the first tone. The letter E is displayed alongside the altered tone frequency. The EXTEND arrow changes to CANCEL E. Press this key to revert to normal tones operation.
- (11) To generate the tones sequence, press the key which is arrowed by TONE STEP, TONE BURST or CONTINUOUS as required. The CONTINUOUS arrow changes to TONES STOP to enable the continuous operation to be interrupted.
- (12) If required, select a frequency offset in the range >9% by pressing the key which is arrowed by FREQ SHIFT. Enter the offset using one of the keys 0 to 9 with a minus sign when appropriate. All the previously selected tone frequencies are reset and displayed.
- (13) To return to the AUDIO TEST display, press the key which is arrowed by RETURN. If CONTINUOUS has been selected, the tones continue to be transmitted.

To decode a programmed tones sequence in the AUDIO TEST mode, proceed as follows:-

- (1) Select RX TEST **[1]** and AF GEN **[4]** . The AUDIO TEST display appears.
- (2) Connect the output of the unit under test to the AF INPUT socket **[15]** .
- (3) Select TONES **[16]** . From the TONES menu, select SEQUENTIAL DECODE. The SEQUENTIAL TONES menu appears.

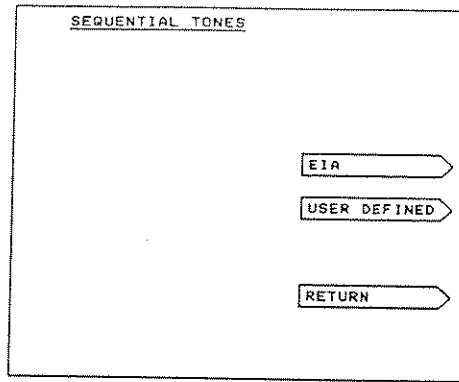

Fig. 3-48 SEQUENTIAL TONES menus

- (4) To return to the AUDIO TEST display at any time, press the key which is arrowed by RETURN.
- (5) From the options on the SEQUENTIAL TONES menu, select the required frequency standard as described under 'Transmitter test' (e.g. CCIR). The appropriate AF SEQUENTIAL TONES display appears.

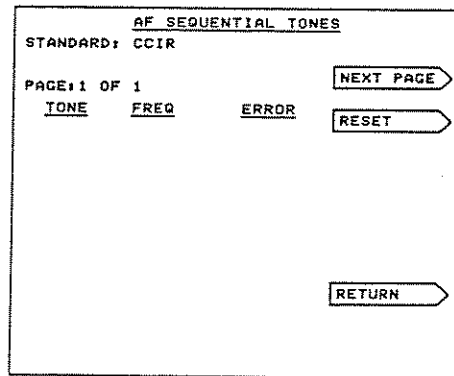

Fig. 3-49 AF SEQUENTIAL TONES display for decoding CCIR

- (6) On the equipment under test, activate the tones which are to be decoded. When triggered, the instrument displays ACTIVE.
- (7) At the end of each measurement, ACTIVE is removed and the decoded tone number, frequency and % error are displayed. If it is within 5% of a standard frequency, the closest tone number is displayed along with the associated error. If the error is worse than 2%, an asterisk is displayed next to the tone number.
- (8) For another test, press the key which is arrowed by RESET. This changes to READY. Otherwise, return to the AUDIO TEST display by pressing RETURN.

To select a user-defined standard, execute (1) to (3) as above and then proceed as for 'Transmitter testing' (5) to (9) and then (10) as above.

If the input level changes, go back to the AUDIO TEST display so that the autoranging is reset.

REVERTIVE SEQUENTIAL TONES OPERATION

When this is used, the instrument generates a sequential tone sequence for sending to a receiver, the receiver decodes it, its transmitter produces an answering sequence and then the instrument decodes the received signal from the transmitter.

Proceed as follows:-

- (1) Select RX TEST 1 . The RECEIVER TEST display appears.
- (2) Connect the unit under test either to RF IN/OUT BNC socket 10 or N socket 12 . Press SELECT 7 until the LED lights above the selected socket.
- (3) Set the RF generator frequency, the RF generator level and the modulation level as previously described under 'Receiver testing'.
- (4) Select TONES 16 . From the TONES menu, select SEQUENTIAL. The SEQUENTIAL TONES menu appears as under 'Receiver testing'.
- (5) To return to the RECEIVER TEST display at any time, press the key which is arrowed by RETURN.
- (6) From the options on the SEQUENTIAL TONES menu, select REVERTIVE. The RX REVERTIVE SEQUENTIAL TONES display first page appears.

RX REVERTIVE SEQUENTIAL TONES	
TX FREQ: 300.00000MHz	CHANGE ▶
POWER: HIGH > 1W	CHANGE ▶
SEND STANDARD: CCIR	CHANGE ▶
MOD LEVEL: 2.000kHz	CHANGE ▶
RECEIVE STANDARD: CCIR	CHANGE ▶
MOD TYPE: FM	CONTINUE ▶
	RETURN ▶

Fig. 3-50 RX REVERTIVE SEQUENTIAL TONES display first page

- (7) Set the incoming TX FREQ using the FREQ key 5 , the DATA keypad 6 and a FREQ/LEVEL terminator key 8 as for a generator.
- (8) Set the POWER sensitivity to LOW <1 W or HIGH >1 W by pressing the CHANGE key which is alongside.
- (9) Set the outgoing SEND STANDARD to CCIR, ZVEI, DZVEI, EIA, EEA or user-defined (UD) by pressing the CHANGE key which is alongside. The user-defined frequencies are as set under 'Sequential tones'.
- (10) Set the incoming RECEIVE STANDARD to CCIR, ZVEI, DZVEI, EIA, EEA or user-defined (UD) by pressing the CHANGE key which is alongside. The user-defined frequencies are as set under 'Sequential tones'.

LOCAL OPERATION

- (11) Set the incoming MOD TYPE to AM, FM or Φ M by pressing the appropriate MOD key [9] .
- (12) Press the CONTINUE key. The RX REVERTIVE SEQUENTIAL TONES display second page appears.

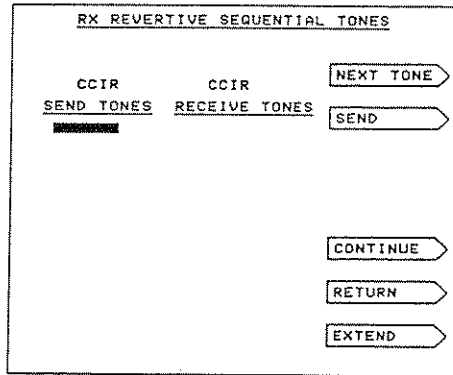

Fig. 3-51 RX REVERTIVE SEQUENTIAL TONES display second page

- (13) Define a programmed tones sequence of up to 11 tones as previously described under 'Sequential tones' by using the NEXT TONE key and the keypad [6] or the VARIABLE control [13] .
- (14) To generate the tones sequence, press the SEND key.
- (15) To return to the RX REVERTIVE SEQUENTIAL TONES menu, press the CONTINUE key.
- (16) To return to the RECEIVER TEST display, press the RETURN key.

DTMF (DUAL-TONE MULTI-FREQUENCY) OPERATION

When this is used, each digit is coded into two simultaneous frequencies as follows:-

Hz	1209	1336	1477	1633
697	1	2	3	A
770	4	5	6	B
852	7	8	9	C
941	*	0	#	D

Transmitter testing

The instrument generates a DTMF sequence for sending to a transmitter, the transmitter produces a modulated RF signal and then the instrument decodes the received signal from the transmitter.

Proceed as follows:-

- (1) Select TX TEST [2]. The TRANSMITTER TEST display appears.
- (2) Connect the audio input of the unit under test to the AF GEN OUTPUT socket [14].
- (3) Connect the RF output of the unit under test to either the RF IN/OUT BNC socket [10] or N socket [12]. Press SELECT [7] until the LED lights above the selected socket.
- (4) Key up the transmitter and ensure that the instrument is correctly tuned to the transmitter's frequency.
- (5) Select TONES [16]. From the TONES menu, select DTMF. The DTMF GENERATOR AND DECODER display appears.

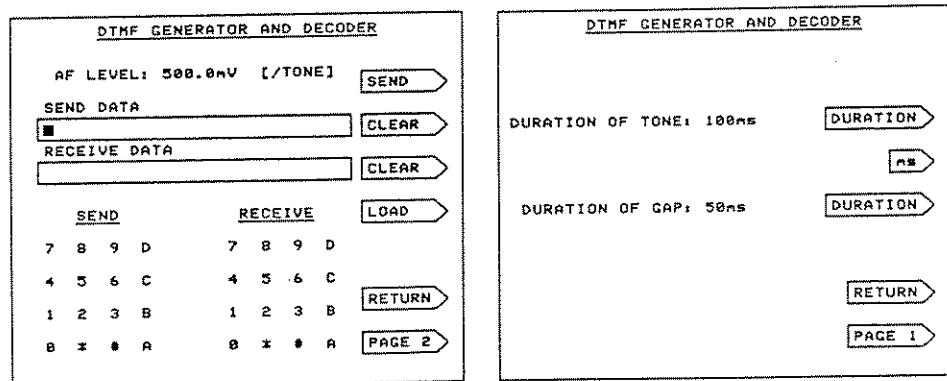

Fig. 3-52 DTMF GENERATOR AND DECODER display pages 1 and 2 for transmitter testing

- (6) To return to the TRANSMITTER TEST display at any time, press the key which is arrowed by RETURN.

LOCAL OPERATION

- (7) Set the AF LEVEL (/TONE, i.e. the level of each of the two tones) as described under 'Transmitter testing'.
- (8) To send single digits, press keys 0 to 9 and adjacent keys as shown on the SEND mimic.
- (9) To enter a sequence of digits in the SEND DATA field, press the CLEAR key which is alongside, press the LOAD key and then press keys 0 to 9 and adjacent keys as shown on the SEND mimic.
- (10) To change one or more digits, turn the VARIABLE control **[13]** to highlight a digit and then press a DATA key **[6]** or the DELETE key **[7]**. To terminate the entry, press the LOAD key again.
- (11) To generate the tones sequence, press the SEND key. The received tones are decoded and shown in the RECEIVE DATA field which scrolls to the left when it is full.
- (12) To clear the RECEIVE DATA field, press the CLEAR key which is alongside.
- (13) To return to the TRANSMITTER TEST display, press the RETURN key.

To select different tones timing, execute (1) to (5) as above and then proceed as follows:-

- (6) Press the key which is arrowed by PAGE 2.
- (7) Set the DURATION OF TONES by pressing the key alongside which is arrowed by DURATION and then entering the duration (in the range 10 to 999) in ms using the keypad **[6]**. Terminate by pressing the key which is arrowed by ms.
- (8) Set the DURATION OF GAP as in (2).
- (9) Press the key which is arrowed by PAGE 1.

Receiver testing

The instrument generates a DTMF sequence for modulating the RF generator, the receiver produces a demodulated AF signal and then the instrument decodes the received AF signal from the receiver.

Proceed as follows:-

- (1) Select RX TEST **[1]**. The RECEIVER TEST display appears.
- (2) Set the RF frequency and the RF level as described under 'Receiver testing'.
- (3) Connect the RF input of the unit under test to either the RF IN/OUT BNC socket **[10]** or N socket **[12]**. Press SELECT **[11]** until the LED lights above the selected socket.
- (4) Connect the audio output of the unit under test to the AF INPUT socket **[15]**.

- (5) Select TONES **[16]** . From the TONES menu, select DTMF. The DTMF GENERATOR AND DECODER display appears.

The figure shows two pages of the DTMF GENERATOR AND DECODER display. The left page (Page 2) has the following layout:

- Header: DTMF GENERATOR AND DECODER
- MOD LEVEL: 4.300kHz [/TONE] with a SEND button.
- SEND DATA field with a CLEAR button.
- RECEIVE DATA field with a CLEAR button.
- A keypad with columns labeled SEND and RECEIVE, and a LOAD button.
- Buttons for RETURN and PAGE 2.

The right page (Page 1) has the following layout:

- Header: DTMF GENERATOR AND DECODER
- DURATION OF TONE: 100ms with a DURATION button and a ms button.
- DURATION OF GAP: 50ms with a DURATION button.
- Buttons for RETURN and PAGE 1.

Fig. 3-53 DTMF GENERATOR AND DECODER display pages 1 and 2 for receiver testing

- (6) To return to the RECEIVER TEST display at any time, press the key which is arrowed by RETURN.
- (7) Set the MOD LEVEL (/TONE, i.e. the level of each of the two tones) as described under 'Receiver testing'.
- (8) To enter a sequence of digits in the SEND DATA field, press the CLEAR key which is alongside, press the LOAD key and then press keys 0 to 9 and adjacent keys as shown on the SEND mimic.
- (9) To change one or more digits, turn the VARIABLE control **[13]** to highlight a digit and the press a DATA key **[6]** or the DELETE key **[7]** . To terminate the entry, press the LOAD key again.
- (10) To generate the tones sequence, press the SEND key. The received tones are decoded and shown in the RECEIVE DATA field which scrolls to the left when it is full.
- (11) To clear the RECEIVE DATA field, press the CLEAR key which is alongside.
- (12) To return to the RECEIVER TEST display, press the RETURN key.

To select different tones timing, execute (1) to (5) as above and then proceed as follows:-

- (6) Press the key which is arrowed by PAGE 2.
- (7) Set the DURATION OF TONES by pressing the key alongside which is arrowed by DURATION and then entering the duration (in the range 10 to 999) in ms using the keypad **[6]** . Terminate by pressing the key which is arrowed by ms.
- (8) Set the DURATION OF GAP as in (2).
- (9) Press the key which is arrowed by PAGE 1.

Duplex testing

This is exactly the same as described under 'Receiver testing' except that RF connections are as described under 'Duplex testing'.

Audio testing

This is exactly the same as described under 'Transmitter testing' except that the AF output of the unit under test is connected to the AF INPUT socket **15**.

DCS (DIGITALLY-CODED SQUELCH) OPERATION

Transmitter testing

The transmitter under test produces a modulated RF signal and the instrument decodes the received signal from the transmitter.

Proceed as follows:-

- (1) Select TX TEST **2**. The TRANSMITTER TEST display appears.
- (2) Connect the RF output of the unit under test to either the RF IN/OUT BNC socket **10** or N socket **12**. Press SELECT **11** until the LED lights above the selected socket.
- (3) Key up the transmitter and ensure that the instrument is correctly tuned to the transmitter's frequency.
- (4) Select TONES **16**. From the TONES menu, select DCS. The DCS DECODER display appears.

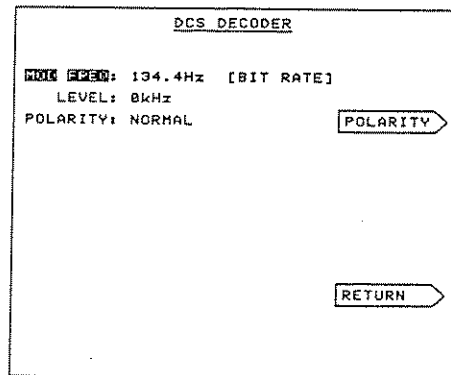

Fig. 3-54 DCS DECODER display

- (5) To return to the TRANSMITTER TEST display at any time, press the key which is arrowed by RETURN.

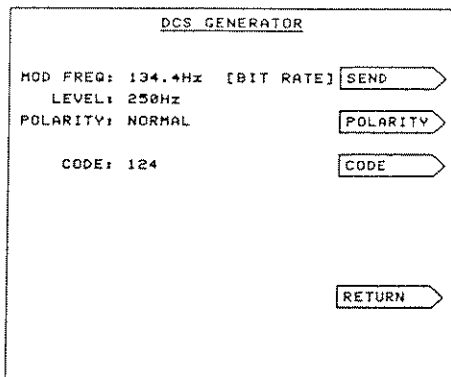

Fig. 3-56 DCS GENERATOR display

- (6) To return to the RECEIVER TEST display at any time, press the key which is arrowed by RETURN.
- (7) Set the modulation frequency (bit rate) by selecting FREQ [5] and using the keypad [6] and the Hz terminator key [8] or the VARIABLE control [13].
- (8) Set the sub-audible deviation level by selecting LEVEL and using the keypad [6] and a terminator key [8] or the VARIABLE control [13].
- (9) Set the bit polarity by using the POLARITY key. NORMAL is for a positive-going 1; INVERTED is for a negative-going 1.
- (10) Press the CODE key. This changes to ENTER. Enter the 3-octal-digit (0 to 7) address code by using the keypad [6] or the VARIABLE control [13]. Press the ENTER key.
- (11) To generate the address, press the SEND key. This changes to STOP. SENDING DATA flashes on the display.
- (12) To stop generation, press the STOP key. Until STOP is pressed, generation continues behind other operations, DCS is shown in reverse video on the RECEIVER TEST and DUPLEX test displays, the second AF generator cannot be reset and pressing TONES causes the DCS GENERATOR display to appear immediately.
- (13) To return to the RECEIVER TEST display, press the RETURN key.

Duplex testing

This is exactly the same as described under 'Receiver testing' except that the RF connections are as described under 'Duplex testing'.

POCSAG RADIO PAGER TESTING

The instrument produces an RF signal which is modulated by 32-bit code words of the following form:-

No. of bits	Symbol	Purpose
1	M	Message/address
18	A	Address
2	F	Function
10	C	Check
1	P	Parity

Proceed as follows:-

- (1) Select RX TEST 1 or DUPLEX TEST 17. The RECEIVER TEST display or the DUPLEX test display appears.
- (2) To the RF IN/OUT BNC socket 10, connect the Telescopic Antenna which is available as an optional accessory. See under 'Accessories' in Chap. 1.
- (3) Select TONES 16. From the TONES menu, select POCSAG. The POCSAG RADIO PAGER TEST display appears.

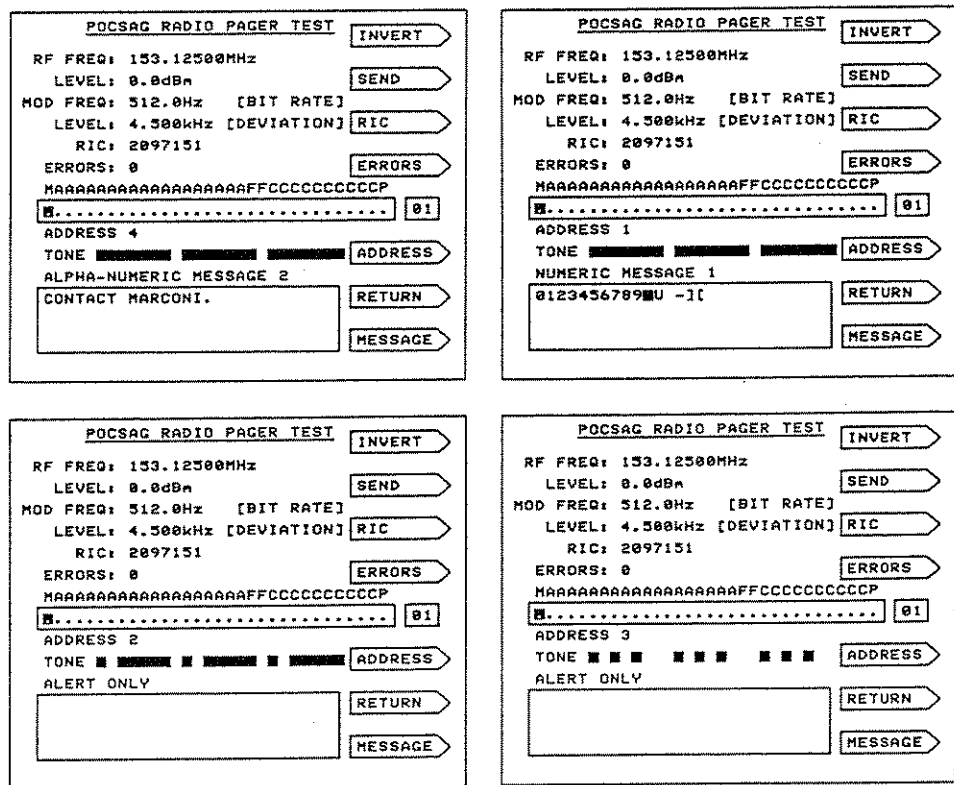

Fig. 3-57 POCSAG RADIO PAGER TEST display with four addresses

LOCAL OPERATION

- (4) To return to the RECEIVER TEST display or the DUPLEX test display at any time, press the key which is arrowed by RETURN.
- (5) When required, set the pager's RF frequency. Each 2955B is programmed either for a default value of 153.125 MHz (European) or of 152.24 MHz (North American). To change the default value, see under 'TONE STANDARD selection'.
- (6) Set a suitable RF level, the modulation frequency (bit rate) and the modulation level as described under 'Receiver testing'. The modulation level is the deviation of the FSK bits 0 and 1 on each side of the carrier.
- (7) To enter the pager's 7-digit RIC (radio identification code), press the RIC key and use the keypad **[6]**. RIC changes to ENTER (flashing) when the first digit is pressed. To enter the RIC, press the ENTER key which then changes back to RIC. This remains highlighted in reverse video and available for another entry until the key is pressed again.
- (8) To choose one of the four addresses, press the ADDRESS key once or more. The appropriate ringing TONE is displayed pictorially.
- (9) Address 1 has two numeric messages. Addresses 2 and 3 are ALERT ONLY. Address 4 has three alpha-numeric messages (all languages) or four alpha-numeric messages (English only). The messages are displayed in the lower box. To select the message, press the MESSAGE key once or more.
- (10) To change the signal polarity, press the INVERT key. The MOD LEVEL reading is then preceded by - in reverse video. To change the polarity back again, press the NORMAL key.
- (11) Errors can be created in the address code word. The errors are displayed in the upper box. To create an error or delete an existing error, press the ERRORS key which then changes to CHANGE (flashing). Press the CHANGE key to change the bit which is highlighted in reverse video. Use the VARIABLE control **[13]** to select the highlighted bit. The number of this bit is displayed in the small right-hand box. E is shown for each error. Against ERRORS, the total number of errors is shown. To delete all errors simultaneously, press the ERROR key and then the DELETE key **[7]**.
- (12) To generate the test signal, press the SEND key. SENDING DATA flashes on the display. The pager does not respond until all the address and message code words have been completed.
- (13) To return to the RECEIVER TEST display or the DUPLEX test display, press the RETURN key.

Help key operation

HELP KEY

When the HELP key is pressed, the HELP menu is displayed which enables you to obtain an operating summary, provides a choice of alternative parameters and implements the self testing routines. To return to the operating mode, press the key arrowed by RETURN.

<p>HELP</p> <p>TO SELECT THE HELP YOU WANT, PRESS A MODE KEY - ONE OF THE KEYS WITH BLUE MARKING</p>	<p>TRANSMITTER TESTING</p> <p>RECEIVER TESTING</p> <p>DUPLEX TESTING</p> <p>AUDIO TESTING</p> <p>CHANGE PARAMETERS</p> <p>SELF TEST</p> <p>RETURN</p>
<p>SOFTWARE VERSION 01 GPIB 06</p> <p>© MARCONI INSTRUMENTS 1991</p>	

Fig. 3-58 HELP menu

OPERATING SUMMARIES

You can refer to an operating summary by pressing one of the MODE keys which is arrowed by the following:-

- (a) TRANSMITTER TESTING.
- (b) RECEIVER TESTING.
- (c) DUPLEX TESTING.
- (d) AUDIO TESTING.

The HELP ON TESTING operating summary is then displayed. This includes information upon key operation (e.g. to select TRANSMITTER TEST, press the TX TEST key). Note that this is for information only and it is necessary to press the MODE key arrowed by RETURN twice (once to return to the HELP menu and once to return to the operating mode) before pressing the designated key.

HELP ON TRANSMITTER TESTING	
TO SELECT	PRESS
TRANSMITTER TEST	TX TEST
MOD TYPE	FM/AM/PM
DEMOD BANDWIDTH	500/1000/2000/3000/4000/5000/6000/7000/8000/9000/10000
DISTORTION [1kHz]	10/20/30/40/50/60/70/80/90/100
RECEIVE TONES	10/20/30/40/50/60/70/80/90/100
TX FREQ	10/20/30/40/50/60/70/80/90/100
AF GEN	10/20/30/40/50/60/70/80/90/100
	NUMBERS+TERMINATOR.
	NUMBERS+[E/B]+[ENTER]+
	NUMBERS+TERMINATOR.
NOTE	
HIGHLIGHTED PARAMETERS CAN ALSO BE ADJUSTED USING NUMBERS .	RETURN
NUMBERS TOGGLES BETWEEN 15kHz AND 300Hz.	
SCOPE DISPLAYS DEMOD SIGNAL.	

Fig. 3-59 HELP ON TRANSMITTER TESTING display

LOCAL OPERATION

HELP ON RECEIVER TESTING		1 OF 2
TO SELECT	PRESS	
RECEIVER TEST	RECEIVER TEST	
AF BANDWIDTH	BANDWIDTH/COMPRESS	
DISTORTION 1kHz	DISTN	
AF LEVEL IN dBV	DISTN [DISTN]	
SEND TONES	TONES	
NOTE		
DC COUPLING CANNOT BE SELECTED WHEN READING DISTORTION, SINAD OR S/N.		
WHEN DC COUPLED, THE AF VOLTS READING IS TRUE RMS DC+AC. MORE		
DB TOGGLES BETWEEN dBV AND dBR. RETURN		
COMPRESS TOGGLES BETWEEN 15kHz AND 300Hz. SCOPE BANDWIDTH IS FIXED AT 50kHz.		

HELP ON RECEIVER TESTING		2 OF 2
TO ADJUST	PRESS	
RF GEN	RF GEN+[1/5]+[FREQ/LEVEL]+NUMBERS+TERMINATOR.	
MOD GEN	MOD GEN+[1/5]+[FREQ]+[FREQ/LEVEL]+NUMBERS+TERMINATOR.	
NOTE		
RETN1 AND RETN2 BOTH SELECT GEN 1. TO SELECT GEN 2 PRESS RETN2 .		
HIGHLIGHTED PARAMETERS CAN MORE		
ALSO BE ADJUSTED USING PARAMETERS .		
FOR MOD GEN SETTINGS IN MORE RETURN		
DETAIL, PRESS TONES+MOD/AF SETUP .		

Fig. 3-60 HELP ON RECEIVER TESTING display pages 1 and 2

HELP ON DUPLEX TESTING		1 OF 2
TO SELECT	PRESS	
DUPLEX TEST	DUPLEX TEST	
MOD TYPE	FM/AM/PM	
DEMOD BANDWIDTH	BANDWIDTH/COMPRESS	
DISTORTION [1kHz]	DISTN	
AUDIO LEVEL IN dBV	DISTN [DISTN]	
SEND TONES	TONES	
NOTE		
DC COUPLING CANNOT BE SELECTED WHEN READING DISTN, SINAD OR S/N. MORE		
WHEN DC COUPLED, THE AUDIO READING IS TRUE RMS DC+AC. RETURN		
DB TOGGLES BETWEEN dBV AND dBR. COMPRESS TOGGLES BETWEEN 15kHz AND 300Hz.		

HELP ON DUPLEX TESTING		2 OF 2
TO ADJUST	PRESS	
RF GEN	RF GEN+[FREQ/LEVEL]+NUMBERS+TERMINATOR.	
MOD GEN	MOD GEN+[FREQ/LEVEL]+NUMBERS+TERMINATOR.	
AF GEN	AF GEN+[FREQ/LEVEL]+NUMBERS+TERMINATOR.	
NOTE		
RF GEN INCREMENTS ARE AS IN RECEIVER TEST.		
HIGHLIGHTED PARAMETERS CAN MORE		
ALSO BE ADJUSTED USING PARAMETERS .		
FOR MOD AND AF GEN SETTINGS IN MORE RETURN		
DETAIL, PRESS TONES+MOD/AF SETUP .		

Fig. 3-61 HELP ON DUPLEX TESTING display pages 1 and 2

HELP ON AUDIO TESTING	
TO SELECT	PRESS
AUDIO TEST	RECEIVER TEST+AF GEN
AF BANDWIDTH	BANDWIDTH/COMPRESS
DISTORTION [1kHz]	DISTN
SEND TONES	TONES
AF GEN	AF GEN+[1/5]+[FREQ]+[FREQ/LEVEL]+NUMBERS+TERMINATOR.
NOTE	
WHEN DC COUPLED, THE AF VOLTS READING IS TRUE RMS DC+AC.	
DB TOGGLES BETWEEN dBV AND dBR. RETURN	
COMPRESS TOGGLES BETWEEN 50kHz AND 300Hz.	
FOR AF GEN SETTINGS IN MORE RETURN	
DETAIL, PRESS TONES+MOD/AF SETUP .	

Fig. 3-62 HELP ON AUDIO TESTING display

Where summaries occupy two pages, press the MODE key arrowed by CONTINUE to change from one page to another. Return to the HELP menu by pressing the key arrowed by RETURN.

PARAMETERS

Pressing the key arrowed by CHANGE PARAMETERS causes the parameters menu to be displayed. It consists of two pages of options as shown below. The selected state is highlighted in reverse video.

RF LEVEL	EMF PD	▷
STORE FUNCTION	ON OFF	▷
RF COUNTER RESOLUTION	1Hz 10Hz	▷
DEFAULT NOISE READING	S/N BITING	▷
600 Ω BALANCED AF ACCESSORY	FITTED NOT FITTED	▷
20dB AF ATTENUATOR ACCESSORY	FITTED NOT FITTED	▷
	RETURN	▷
	PAGE 2	▷

DEFAULT AF FILTER	15/50kHz LP 15/50kHz LP 300Hz LP	▷
DEFAULT MOD LEVEL	1.500kHz	▷
RX/TX MOD TYPE LOCK	ON OFF	▷
TONE STANDARD	EUROPEAN USA	▷
RF LEVEL OFFSET	0.0dB	▷
GPIB MODE	2955 2955 EMULATION	▷
	RETURN	▷
	PAGE 1	▷

Fig. 3-63 Parameters menu

PAGE 1 allows changes to be made under the following options:-

- (a) RF LEVEL.
- (b) STORE FUNCTION.
- (c) RF COUNTER RESOLUTION.
- (d) DEFAULT NOISE READING.
- (e) 600 Ω BALANCED AF ACCESSORY.
- (f) 20 dB AF ATTENUATOR ACCESSORY.

PAGE 2 allows changes to be made under the following options:-

- (a) DEFAULT AF FILTER.
- (b) DEFAULT MOD LEVEL.
- (c) RX/TX MOD TYPE LOCK.
- (d) TONE STANDARD.
- (e) RF LEVEL OFFSET.
- (f) GPIB MODE.

Pressing PAGE 2 or PAGE 1 selects the other page of the menu; RETURN restores the HELP menu.

RF LEVEL selection

For the level of the RF generator, select either EMF or PD. European practice is to show the output level as PD (loaded) or EMF (unloaded).

STORE FUNCTION selection

To enable or disable the STORE facility, select ON or OFF. OFF prevents existing data being over-written.

RF COUNTER RESOLUTION selection

For frequencies up to 200 MHz, select either 1 Hz or 10 Hz. The resolution is 10 Hz for frequencies above 200 MHz.

DEFAULT NOISE READING selection

When the instrument is switched on, either S/N or SINAD appears in appropriate displays until the SINAD S/N key is used. Select S/N or SINAD.

600 Ω BALANCED AF ACCESSORY selection

The AF GEN LEVEL setting on the TRANSMITTER TEST display, the AF VOLTS reading on the RECEIVER TEST display or the AF GEN LEVEL settings on the AUDIO TEST display is shown in dBm (as appropriate when the 600 Ω Interface Unit is fitted) or V (as appropriate when the 600 Ω Interface Unit is not fitted). Select FITTED for dBm or NOT FITTED for V.

20 dB ATTENUATOR ACCESSORY selection

When a 20 dB Attenuator is fitted to the AF GEN OUTPUT socket, the displayed AF GEN LEVEL can be reduced accordingly. Select FITTED for a reduction of 20 dB or NOT FITTED for the actual level at the socket. When FITTED has been selected, A in reverse video is displayed alongside the FREQ setting.

DEFAULT AF FILTER selection

Select the 0.3 to 3.4 kHz bandpass filter, the 15 or 50 kHz low-pass filter or the 300 Hz low-pass filter.

DEFAULT MOD LEVEL setting

Enter a required modulation level.

RX/TX MOD TYPE LOCK selection

For the DUPLEX test mode, the transmitter's type of modulation can be locked to be that of the receiver. Select either ON (for the same type of modulation) or OFF (for separate setting).

TONE STANDARD selection

For SEQUENTIAL TONES testing, select either EUROPEAN (CCIR, ZVEI, DZVEI and EEA) or USA (EIA).

For POCSAG radio pager testing, the RF frequency has a default value of 153.125 MHz (European) or 152.24 MHz (USA). To change the default value, select the appropriate TONES STANDARD and then switch the instrument off and on again.

RF LEVEL OFFSET setting

When required, enter an offset. This is used to give the appropriate result when an external RF attenuator is fitted. When an offset has been entered, A (highlighted in reverse video) appears against RF levels.

GPIB MODE selection

Select either NORMAL or 2955 EMULATION. 2955 EMULATION is required for use with a Cellular Adapter or when using GPIB software which has been written for the 2955.

SELF TESTING

On the HELP menu, pressing the key arrowed by SELF TEST causes the SELF TEST display to appear. Press the ALL TESTS key to initiate the complete self testing procedure.

SELF TEST		ERROR CODE	NEXT TEST
TEST			
1.0	PASSED		
1.1	PASSED		
1.2	PASSED		
1.3	PASSED		
1.4	PASSED		
2.0	PASSED		
2.1	PASSED		
2.2	PASSED		
2.3	PASSED		
3.0	PASSED		ALL TESTS
3.1	PASSED		
3.2	PASSED		RETURN
3.3	PASSED		

Fig. 3-64 SELF TEST display

During each individual test, ACTIVE is displayed. At the end of each of the thirteen individual tests, either PASSED or FAILED appears against the test number. In the case of a failed test, the error code for the failure is shown. For the meaning of the codes, see Table 3-2, Table 3-3 and Table 3-4.

At any time, the self test can be terminated by pressing the key arrowed by RETURN. At the end of the tests, the instrument waits for RETURN which displays the HELP menu.

Notes...

- (1) Before implementing the self testing procedure, remove any leads which are connected to the coaxial connectors to prevent extraneous pick-up affecting the readings.
- (2) In the RF counter to RF generator power test, the difference in the setting and reading levels is due to one-port duplex operation being selected for the test.

The individual tests can be initiated one at a time (e.g. after a failure). Initiate each individual test by repeatedly using the NEXT TEST key.

TABLE 3-2 ERROR CODES FOR RF COUNTER TO RF GENERATOR
FREQUENCY TEST

Error code (hexadecimal)	Test no.	Frequency	Error
10			None (passed)
11	1.0	20 MHz	High (>50 Hz above set frequency)
12	1.0	20 MHz	Low (>50 Hz below set frequency)
13	1.1	111 MHz	High
14	1.1	111 MHz	Low
15	1.2	218 MHz	High
16	1.2	218 MHz	Low
17	1.3	340 MHz	High
18	1.3	340 MHz	Low
19	1.4	480 MHz	High
1A	1.4	480 MHz	Low
1B			Frequency read failure

TABLE 3-3 ERROR CODES FOR RF POWER METER TO RF GENERATOR
POWER TEST

Error code (hexadecimal)	Test no.	Frequency	RF generator setting	Power meter reading	Error
20					None (passed)
21	2.0	300 MHz	0.25 mW	79 mW	Low (>2 dB below set level)
22	2.0	300 MHz	0.25 mW	79 mW	High (>2 dB above set level)
23	2.1	849 MHz	0.25 mW	79 mW	Low
24	2.1	849 MHz	0.25 mW	79 mW	High
25	2.2	20 MHz	0.25 mW	79 mW	Low
26	2.2	20 MHz	0.25 mW	79 mW	High
27	2.3	20 MHz	0.125 mW	40 mW	Low
28	2.3	20 MHz	0.125 mW	40 mW	High

TABLE 3-4 ERROR CODES FOR MODULATION FREQUENCY AND LEVEL TESTS

Error code (hexadecimal)	Test no.	RF frequency	Modulation frequency	Level	Error
30					None (passed)
31	3.0	210 MHz	400 Hz	5 kHz	Gen. 1 frequency (>1 Hz from setting)
33	3.0	210 MHz	400 Hz	5 kHz	Gen. 1 level low (>10% below setting)
34	3.0	210 MHz	400 Hz	5 kHz	Gen. 1 level high (>10% above setting)
32	3.1	210 MHz	1 kHz	5 kHz	Gen. 2 frequency
35	3.1	210 MHz	1 kHz	5 kHz	Gen. 2 level low
36	3.1	210 MHz	1 kHz	5 kHz	Gen. 2 level high
37	3.2	210 MHz	1 kHz	50%	Gen. 2 level low
38	3.2	210 MHz	1 kHz	50%	Gen. 2 level high
39	3.3	210 MHz	1 kHz	5 rad	Gen. 2 level low
3A	3.3	210 MHz	1 kHz	5 rad	Gen. 2 level high

Transmitter monitoring (Option 1 only)

CONTROLS AND CONNECTORS

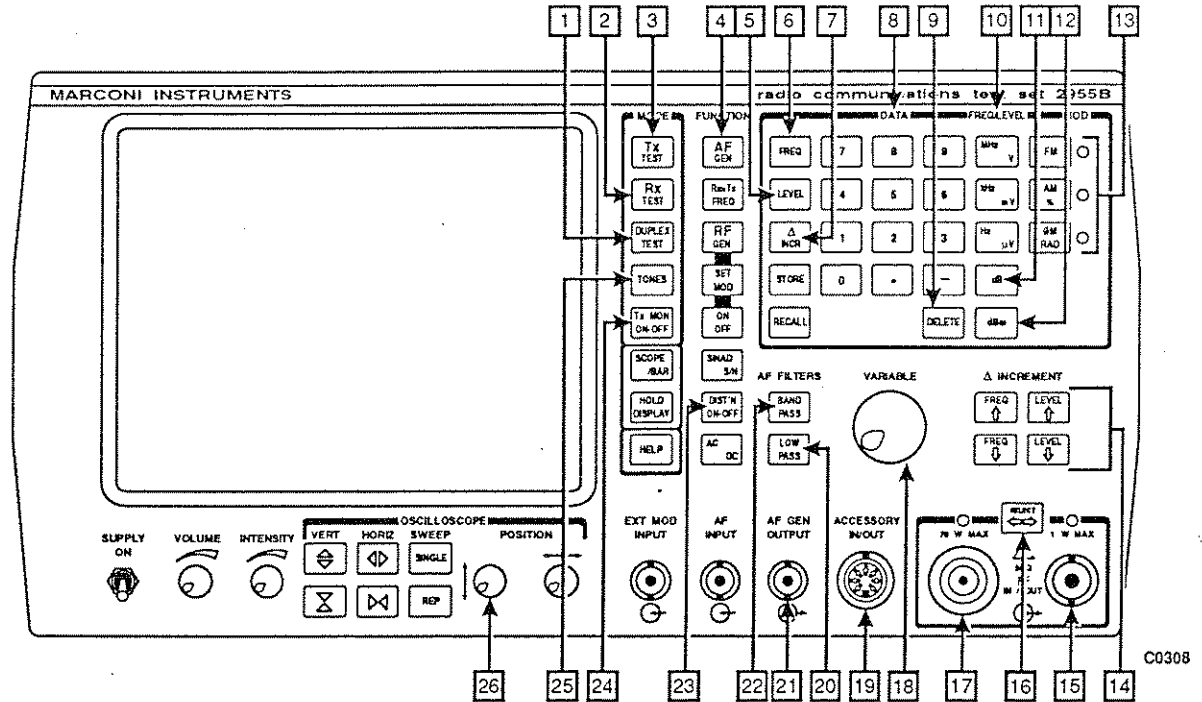

Fig. 3-65 Transmitter monitoring controls and connectors

- 1 **DUPLEX TEST** key. Used as a soft key to select the 12 or 180 kHz IF FILTER as shown alongside on the screen.
- 2 **RX TEST** key. Used as a soft key to select UPPER or LOWER for the RF IMAGE as shown alongside on the screen. Since the image rejection is 0 dB, an incoming signal at the RF image frequency produces the same IF as the wanted source. The use of this key changes the local oscillator frequency so that it is 21.4 MHz above (UPPER) or below (LOWER) the wanted frequency. The key is ineffective below 21.8 MHz and at or above 1038.6 MHz.
- 3 **TX TEST** key. For manual tuning only, used to return to TX after selecting AF GEN 4. TX is shown in reverse video unless AF GEN 4 has been pressed.
- 4 **AF GEN** key. See under 'AF generators'. For manual tuning only, press TX TEST 3 to return to TX.
- 5 **LEVEL** key. Precedes a keypad 8 entry so that the entered data is recognized as a level. GEN LEVEL is shown in reverse video.
- 6 **FREQ** key. Precedes a keypad 8 entry so that the entered data is recognized as a frequency. When applicable, TX FREQ or GEN FREQ is shown in reverse video.

- [7] **Δ INCR key.** Follows a **FREQ** [6] or **LEVEL** [5] entry so that the entered data is recognized as an increment or decrement. When applicable, **TX INCR**, **GEN FREQ INC** or **GEN LEVEL INC** is shown in reverse video. After returning to **TX FREQ** setting, **I** is shown in reverse video until the increment entry is cancelled by entering zero or an **AF GEN** frequency increment.
- [8] **DATA keypad.** For data entry using numerals 0 to 9 and decimal point.
- [9] **DELETE key.** Deletes a preceding digit or decimal point which has been entered on the keypad [8].
- [10] **FREQ/LEVEL keys.** For defining units of frequency. One of these terminates the data entry. When data is not being entered, any one key selects μV or mV for the **STRENGTH** reading. See also [11] and [12].
- [11] **dB key.** Selects a **STRENGTH** reading in $\text{dB}\mu\text{V}$ or dBr . The relative level is set to 0 dBr when the key is pressed.
- [12] **dBm key.** Selects a **STRENGTH** reading in dBm (50 Ω).
- [13] **MOD keys and LEDs.** Enable the type of modulation to be entered. LED lights to show that the **FM**, **AM** or ΦM (**FM** with de-emphasis) route to the demodulator has been selected.
- [14] **Δ INCREMENT keys.** Increase and decrease the frequency and the level by the increments which have been set using [7].
- [15] **RF IN/OUT BNC socket.** For the Telescopic Antenna or another antenna or for a very low-power transmitter or probe. The maximum allowable input to the sensitive receiver is 1 W. Impedance 50 Ω .
- [16] **SELECT key and LEDs.** For selecting **RF IN/OUT** socket [15] or [17]. LED lights above the socket selected.
- [17] **RF IN/OUT N socket.** For higher level inputs. The maximum allowable input to the sensitive receiver is 75 W. Impedance 50 Ω .
- [18] **VARIABLE control.** Analogue control which provides an alternative to the **DATA** keypad [8] for entering data.
- [19] **ACCESSORY socket.** DIN 7-pin connector for an external psophometric (telephone weighting) CCITT or C-message filter option.
- [20] **LOW PASS key.** Selects a 300 Hz or a 15 kHz low-pass filter.
- [21] **AF GEN OUTPUT socket.** BNC socket. For output for modulating the transmitter.
- [22] **BAND PASS key.** Selects a 0.3 to 3.4 kHz band-pass filter or an external filter.
- [23] **DIST'N ON-OFF key.** Causes the distortion reading and bar chart to appear. Distortion is measured using a modulation frequency of 1 kHz. This can be supplied from the **AF GEN OUTPUT** socket [21].

- 24 TX MON ON-OFF key. Causes the TX MONITOR MODE SELECTION MENU to be displayed.
- 25 TONES key. Causes the TONES menu to be displayed. See under 'Transmitter testing'.
- 26 POSITION \leftrightarrow control. In the TRANSMITTER MONITOR mode, this is used as the SQUELCH control. The legend SQ is shown on the display. When this control is fully anti-clockwise, the modulation meter outputs (loudspeaker, oscilloscope trace, MOD FREQ reading, MOD LEVEL reading and DE-MOD OUT signal) are enabled. Turn this control clockwise to increase the carrier threshold level below which the modulation meter outputs are disabled. When the carrier level is below the threshold level, the MOD FREQ reading is replaced by -SQUELCH- in reverse video.

OPERATION

Introduction

Proceed as follows:-

- (1) Press the TX MON ON-OFF key 24 . The TX MONITOR MODE SELECTION MENU appears. This gives the choice of manual tuning, start and step tuning or selected frequencies tuning as detailed below.
- (2) Press the MANUAL TUNE, the START + STEP or the SELECTED FREQS soft key and then proceed as described under the separate headings. To return to the previous mode, press the RETURN key.

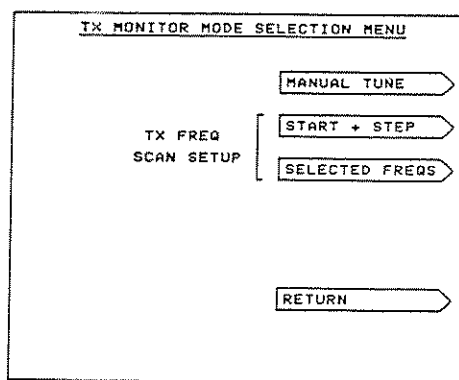

Fig. 3-66 TX MONITOR MODE SELECTION MENU

Manual tuning

When the MANUAL TUNE soft key has been pressed, the TRANSMITTER MONITOR display appears.

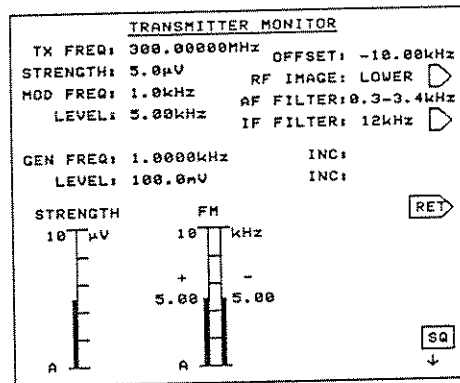

Fig. 3-67 TRANSMITTER MONITOR display for manual tuning

Continue as follows:-

- (1) Set the TX FREQ, the frequency at which the transmitter is expected to transmit, by using the FREQ key [6], the DATA keypad [8] and a FREQ/LEVEL key [10]. On the screen, OFFSET is the difference between this frequency and the transmitter's measured frequency.
- (2) When required, set a frequency increment by using the Δ INCR key [7] and the FREQ ↑ and FREQ ↓ keys [14]. When an increment has been entered, I is shown in reverse video alongside the transmitter frequency.
- (3) Connect the Telescopic Antenna (a supplied accessory) to the RF IN/OUT BNC socket [15] or another antenna to the RF IN/OUT BNC socket [15] or N socket [17].
- (4) Press SELECT [16] until the LED lights above the appropriate RF IN/OUT socket [15] or [17].
- (5) Select the transmitter's type of modulation by pressing the MOD FM key, the MOD AM % key or the MOD ΦM key [13].
- (6) Using RX TEST [2] as a soft key, select the RF IMAGE as UPPER or LOWER.
- (7) Using DUPLEX TEST [1] as a soft key, select the IF FILTER as 12 or 180 kHz.
- (8) Select the unit of the STRENGTH reading by pressing one of the FREQ/LEVEL keys [10] for μV or mV, the dB key [11] for dBμV or the dBm key [12] for dBm (50 Ω).

LOCAL OPERATION

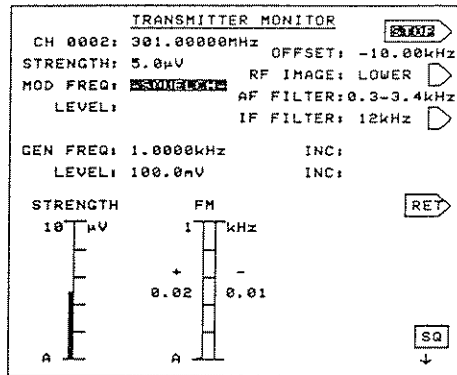

Fig. 3-70 TRANSMITTER MONITOR display during scanning

- (4) When scanning has stopped, the frequency can be stepped manually by using the FREQ ↑ and FREQ ↓ keys [18] provided that an AF FREQ increment has not been entered.

Selected frequencies tuning

When the SELECTED FREQS soft key has been pressed, the TX MONITOR SELECTED FREQS MENU appears. This menu allows the user to define a frequency scanning sequence under the following options:-

- (a) DISPLAY CHAN. Select ON when a channel number is to be displayed for each frequency.
- (b) FREQUENCY. Enter up to eleven different frequencies.
- (c) CHANNEL. When required, enter the channel number which is to be displayed for each frequency.

For the DISPLAY CHAN option, there is a SELECT soft key. This can be used to toggle between ON and OFF.

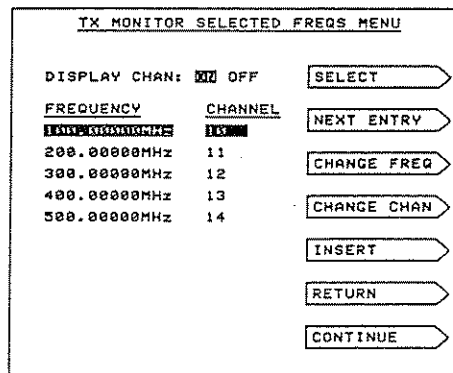

Fig. 3-71 TX MONITOR FREQS MENU with five entries

For the frequency and the channel options, there is a NEXT ENTRY soft key and an INSERT soft key with which to access the required frequency. The selected entry appears in reverse video. For each option, there is a CHANGE key which has to be pressed once and then it changes to ENTER. The numerical setting can then be changed by entering a new value on the DATA keypad [8]. If a mistake is made, press the DELETE key [9] and then press the correct key. Any change can be aborted by pressing any other soft key. If the entry is correct, press the ENTER key or a FREQ/LEVEL key. The ENTER key then changes back to CHANGE. If a mistake is now found in the data, the number has to be re-entered after pressing CHANGE. To delete a whole frequency and channel entry, press the DELETE key [9] before using the DATA keypad [8].

Continue as follows:-

- (1) After the introductory procedure and entering any changes in the SELECTED FREQS MENU, press the CONTINUE soft key. The TRANSMITTER MONITOR display appears (as for START + STEP scanning).
- (2) When required, proceed as for manual tuning (5) to (12).
- (3) Press the SCAN soft key which changes to STOP in reverse video (as for start and step tuning). To stop scanning at any time, press the STOP key. Otherwise, the sequence of frequencies is scanned repeatedly until a carrier is found and -SQUELCH- is replaced by the modulation frequency. The STOP key then reverts to SCAN. To return to the previous mode, press the RETURN key.
- (4) When scanning has stopped, the frequency can be stepped manually by using the FREQ ↑ and FREQ ↓ keys [18] provided that an AF FREQ increment has not been entered.

Store and recall operation

INTRODUCTION

By using the STORE key, the user can store front panel settings except those of the analogue controls such as intensity, volume etc.

Each store has a 2-digit number in the range 00 to 26. Store 00 is automatically allocated to instrument settings at switch-off or loss of mains or battery power. Store 26 is automatically allocated to a Cellular Adapter for set-up information.

By using the RECALL key, the user can restore settings which were previously stored.

STORE PROCEDURE

This is enabled when the STORE FUNCTION is selected as ON in the parameters menu. Proceed as follows:-

- (1) Press the STORE key. The STORE/RECALL MENU appears.

STORE/RECALL MENU		
NO	MODE	TITLE
00	RX	POWER OFF
01	RX	DEFAULT
02	RX	DEFAULT
03	RX	DEFAULT
04	RX	DEFAULT
05	RX	DEFAULT
06	RX	DEFAULT
07	RX	DEFAULT
08	RX	DEFAULT
STORE_		
BCDEFGHIJKLMNOPQRSTU		
VWXYZ0123456789/-.*#		

COPY STORE →

EDIT TITLE →

ENTER →

STEP → →

STEP ← ←

RETURN →

PAGE 2 →

Fig. 3-72 STORE/RECALL MENU

- (2) On the DATA keypad, enter a 2-digit store number.
- (3) If required, enter a title as described below.
- (4) To return to the previous display, press the RETURN key.

To enter a title, proceed as follows:-

- (1) Press the EDIT TITLE soft key. This changes to END EDIT and EDIT TITLE NO: appears.
- (2) On the DATA keypad, enter the 2-digit store number.
- (3) Rotate the VARIABLE control to select each character and press the ENTER soft key for each one. Alternatively, press keys on the DATA keypad.
- (4) Use the STEP→ and STEP← soft keys to change the position of the entry cursor.

- (5) Page 1 has stores 00 to 08. Press the PAGE 2 soft key for stores 09 to 17. Press the PAGE 3 soft key for stores 18 to 26. Press the PAGE 1 soft key to return to stores 00 to 08.
- (6) Press the END EDIT soft key which changes back to EDIT TITLE.

To renumber a store, proceed as follows:-

- (1) Press the COPY STORE soft key. COPY FROM: appears.
- (2) On the DATA keypad, enter the 2-digit number of the source store. TO: appears.
- (3) On the DATA keypad, enter the new 2-digit number.

RECALL PROCEDURE

Proceed as follows:-

- (1) Press the RECALL key. The STORE/RECALL MENU appears.
- (2) On the DATA keypad, enter a 2-digit store number. The stored display appears.

Except when the STORE FUNCTION is selected as OFF in the parameters menu, titles can be entered and stores can be copied. See under 'Store procedure'.

Printer operation

INTRODUCTION

Any Listen Only printer can be used with the 2955B. The 24 Column Printer (part no. 54211-001D) is available as an optional accessory. See under 'Accessories' in Chap. 1.

POWER SUPPLIES

When operating with the 2955B, the 24 Column Printer uses the ACCESSORY socket for its power supply. For stand-alone operation, it requires a supply of 12 V at 2 A peak. Any other printer may need its own power supply. However, the ACCESSORY socket (pin 2) can be used for +12 V at approximately 100 mA continuous.

GPIB CONNECTIONS

The GPIB socket on the printer is connected to the GPIB Interface Unit which is fitted at the rear of the 2955B. The GPIB Lead Assembly (part no. 43129-189U) is available as an optional accessory. For use with IEC connectors, the IEEE to IEC Adapter is available as an optional accessory. See under 'Accessories' in Chap. 1.

PRINTING

To use the 24 Column Printer for measurement results, proceed as follows:-

- (1) Make the power supply and GPIB connections as given above.
- (2) On the 2955B's GPIB Interface Unit, set the TALK ONLY switch 6 to on (not OPEN). In the Talk Only mode, switches 3, 4 and 5 are inoperative. Set switches 1 and 2 as required as follows:-

Switch		Function
ADDRESS 16 (1)	ADDRESS 8 (2)	
0	0	Upper and lower case, <CR> suppressed
0	1	Upper and lower case <CR> not suppressed
1	0	Upper case only, <CR> suppressed
1	1	Upper case only, <CR> not suppressed

- (3) Switch off the 2955B and then switch it on again to enable the instrument to read the new switch settings.
- (4) Press the HOLD DISPLAY key. HOLD OFF is displayed against the SCOPE/BAR key and PRT appears against the HELP key.
- (5) Press the key arrowed by PRT. This starts the Printer and results in a printout of the major settings and readings shown in the top half of the display. See the example in Fig. 3-72. Once printing has started, there is no way to abort it.

- (6) When using the ACCESSORY socket for power, the screen may be affected (e.g. the sides may be drawn in) due to power drain, especially when printing rows of dots. This is unimportant and does not affect measurement results since these are already frozen.

```
      TRANSMITTER TEST
      -----
      SETTINGS
      -----
      AF1 FREQ:1.0000kHz
        LEVEL:100.0mV
      AF2 FREQ:1.0000kHz
        LEVEL:100.0mV  OFF
        FILTER:0.3-3.4kHz

      READINGS
      -----
      TX FREQ:299.99968MHz
        POWER:0.84mW
      MOD FREQ:1.000kHz
        LEVEL:1.51kHz
        DISTN:1.4%

      MODEL:.....
      SER NO:.....
      DATE:.....
```

Fig. 3-73 Example of the printout for a transmitter test

For further information, refer to the Instruction Manual for the printer.

Chapter 4

REMOTE OPERATION

GPIB Interface Unit

INTRODUCTION	4-3
SWITCH SETTINGS	4-3
DISPLAY	4-4

Serial Interface Unit

INTRODUCTION	4-5
SWITCH SETTINGS	4-5
Data rate	4-5
Data bits and parity bits	4-5
Xon/Xoff protocol	4-5
Talk only	4-5
DISPLAY	4-6
LOCAL COMMANDS	4-6

Commands for the 2955B

INTRODUCTION	4-7
SYNTAX	4-7
Conventions	4-7
Delimiters	4-7
Command format	4-7

Command codes

COMMAND CODES FOR KEYS	4-9
OTHER COMMAND CODES	4-9
ASCII CODES	4-9
SUMMARY	4-9

Writing a program

OPERATING EXAMPLE	4-23
GPIB CONTROLLER PROGRAMS	4-23
COMPUTER PROGRAMS	4-24
COMMAND INPUT	4-24
DATA OUTPUT	4-24
STATUS BYTE AND SERVICE REQUESTS	4-25
CREATING A SCREEN DISPLAY	4-25
Screen commands	4-25
WR (WRite) commands	4-26
Character set	4-28
Reverse video characters	4-28
Graticule elements	4-31
BX (BoX) commands... ..	4-31
User-defined display examples	4-32

GPIB Interface Unit

INTRODUCTION

This unit is for the remote control of a 2955B (along with fourteen other devices) by means of a GPIB (general purpose interface bus) controller and suitable GPIB cabling. Further information on the general features and applications of the GPIB system can be obtained from the separate GPIB Manual which is offered as an optional accessory. See under 'Accessories' in Chap. 1.

The GPIB controller is a microcomputer with a GPIB interface circuit and with GPIB system software. At the keyboard, a high-level language (e.g. BASIC) is used. Commands for the 2955B are embedded in high-level statements. The controller converts these into the appropriate signals on the GPIB. The 2955B converts the GPIB signals back into its own commands.

The controller can be operated in immediate mode or programs can be saved and then loaded and run.

There is a wide range of controllers and details of operations. However, examples are given for a typical technical computer.

SWITCH SETTINGS

The instrument's address can be selected on the switch bank which is positioned on the GPIB Interface Unit on the rear of the instrument. See Fig. 4-1.

For the talk and listen mode, set the TALK ONLY switch 6 to OPEN (0). Set the ADDRESS 2 and 4 switches (4 and 3) to on (not OPEN) to give an address of 6 (or set any other address in the range 0 to 30 decimal).

For the talk only mode, set the TALK ONLY switch 6 to not OPEN (1). The positions of ADDRESS 1, 2 and 4 (5, 4 and 3) are irrelevant. Set the ADDRESS 16 and 8 switches (1 and 2) as required as follows:-

Switch		Function
ADDRESS 16 (1)	ADDRESS 8 (2)	
0	0	Upper and lower case, <CR> suppressed
0	1	Upper and lower case <CR> not suppressed
1	0	Upper case only, <CR> suppressed
1	1	Upper case only, <CR> not suppressed

When the HELP key is pressed, the HELP menu is displayed. This shows the GPIB address at the bottom of the screen. In the talk only mode, T is shown after the listen address.

Note...

If any switch position is changed, switch off the instrument and then switch it on again so that the instrument reads the new setting(s).

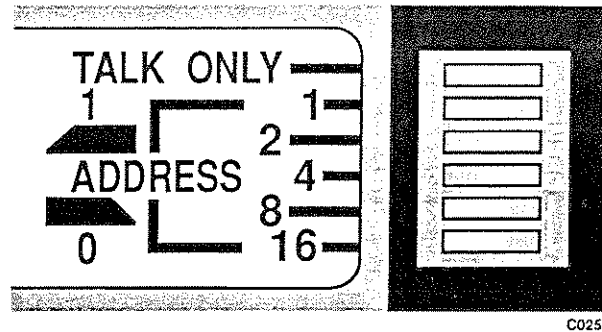

Fig. 4-1 Switches on the GPIB Interface Unit set to the talk and listen mode and to address 6 (2 + 4)

DISPLAY

During GPIB operation, the following are shown on the screen:-

- (a) REM. Once the instrument has received a remote enable and has been addressed, it enters the remote state. REM appears in reverse video in the bottom right-hand corner of the screen.
- (b) ADR. When it is in the remote condition and the instrument is addressed to either talk or listen, ADR appears in reverse video in the bottom right-hand corner of the screen.
- (c) SRQ. When it is in the remote condition and enabled, a service request is raised. SRQ appears in reverse video in the bottom right-hand corner of the screen.
- (d) LCL. When it is in the remote condition and LLO (Local Lockout) has not been sent, LCL (LoCaL) appears next to the HELP key. Pressing HELP then causes the instrument to enter the GTL (Go To Local) condition. The GTL condition is not the same as the power-on condition since the REN (Remote Enable) line from the controller is still active.

Serial Interface Unit

INTRODUCTION

This unit is for the remote control of a 2955B using the EIA-232 (formerly RS-232) interface standard. The unit accepts all the GPIB commands for the 2955B and also additional local commands which perform the same function as some of the interface messages on the GPIB. These messages are exclusive to the instrument and are not included in the EIA-232 standard.

SWITCH SETTINGS

On the PCB of the Serial Interface Unit, there is a bank of switches which can be reset as follows:-

Data rate

Switches 1 and 2 are used to set the data rate as follows:-

Baud	Switch 1	Switch 2
600	OFF	OFF
1200	ON	OFF
2400	OFF	ON
9600	ON	ON

Data bits and parity bits

Switches 3 and 4 are used to set 7 or 8 data bits and even or odd parity as follows:-

Data bits	Start bits	Stop bits	Parity bits	Switch 3	Switch 4
7	1	1	Even	OFF	OFF
7	1	1	Odd	OFF	ON
8	1	1	None	ON	OFF or ON

Xon/Xoff protocol

When switch 5 is set to OFF, RTS contact 4 is held high and CTS contact 5 is ignored. The interface responds to stall characters (ASCII 13 decimal) by holding off all character output until unstick (ASCII 11 decimal) is received. In addition, when the interface input buffer is full, the interface sends a stall character.

When switch 5 is set to ON, RTS contact 4 is held high until the input buffer is full. RTS contact 4 is then brought low and a stall character is sent. CTS contact 5 can be used to stall output from the interface.

Talk only

When switch 6 is set to OFF, the 2955B operates in the talk only mode (upper and lower case, <CR> not suppressed). This allows connection to a printer. In this mode, the HOLD DISPLAY key is used to freeze the display. PRT appears alongside the HELP key. Press the key arrowed by PRT to start the printer.

DISPLAY

During remote operation, the following are shown on the screen:-

- (a) REM. Once the instrument has received a remote enable and has been addressed, it enters the remote state. REM appears in reverse video in the bottom right-hand corner of the screen.
- (b) ADR. Except when the Serial Interface Unit is in the talk only mode, ADR appears in reverse video in the bottom right-hand corner of the screen.
- (c) SRQ. When it is in the remote condition and enabled, a service request is raised. SRQ appears in reverse video in the bottom right-hand corner of the screen.

LOCAL COMMANDS

These are not included in the standard EIA-232 set but are normally associated with the GPIB. They are included to provide additional flexibility, particularly when the 2955B is within an automatic test installation.

Local commands are preceded by <ES> (ASCII decimal 27). There are five local commands as follows:-

Command code	Function
SPL	Serial PoLI. Returns one ASCII character (status byte) in the range 0 to 127. The status byte bit locations are the same as for the GPIB except that the MSB (data ready) is omitted.
LLO	Local LOKout. Locks out the front panel control.
GTL	Go To Local. Terminates remote control.
CLR	Device CLear. Performs a GPIB device clear.
TRG	TRIGger. Performs a GPIB Group Execute Trigger <GET>.

Commands for the 2955B

INTRODUCTION

These take the form of a two-letter command code which is sometimes followed by numerical data. These are detailed under 'Command codes'.

Delimiters are required to separate multiple data and multiple statements and to terminate the last command in a string.

The command codes perform different types of function as follows:-

- (a) Normal functions of the keys on the front panel.
- (b) Functions for which the MODE keys are used as soft keys.
- (c) GPIB instructions which are not appropriate to manual operation.
- (d) Requests for readings of measurements and settings which you would normally view on the screen.

SYNTAX

Conventions

The following conventions are used in this manual:-

Notation	Explanation	Example
AAAAAAA	Items which are entered as a string.	TX
<AAAAAA>	ASCII control function which is entered as an ASCII code or ASCII character which is entered as a single key stroke.	<LF>
<aaaaaa>	Information as described which is to be entered as a string.	<data
[]	Entry of the enclosed item is optional.	[<data>]
...	The previous item(s) can be repeated as necessary.	<data><delimiter> ...

Delimiters

There are two types of delimiter as follows:-

- (a) Low priority. <, > or <; > or <SPACE> or <CR>. These are used to separate fields within a statement. These can be omitted when ambiguity does not arise.
- (b) High priority. <LF> (linefeed), <ETX> (end of text) or <ETB> (end of text block). These are used to separate adjacent statements and to terminate the last statement. (When required by the controller, the GPIB bus EOI line can be activated. See under EX.)

Command format

<command code> [<data>][<command code>][<delimiter>] ... <delimiter>

where <command code> is a 2-letter code as given under 'Commands for the 2955B'.

and <data> is an integer (NR1 format) or a fixed decimal point number (NR2 format). Exponential formats are not allowed.

Where there is more than one item of data, delimiters have to be used.

A typical command string (where the data items are separated by commas, the commands are delimited by semicolons and the string is terminated by <LF>) is as follows:-

RX;RG;FR123.5MZ;RD27;CS;WR0,0,TEST RESULT<LF>

Command codes

COMMAND CODES FOR KEYS

There is a command code for each of the normal functions of the keys on the front panel. Functions are as given in Chapter 3 except where otherwise stated. Some of these codes are followed by the data which is shown. See Table 4-1 and Fig. 4-2.

There is a command code for each of the functions for which the MODE keys are used as soft keys to select programmed functions from menus. Functions are as given in Chapter 3. For some of the functions, there are alternative command codes so that they can be entered directly without the user needing to know the existing state. These command codes for direct entry are followed by the data which is shown. See Table 4-2 and Fig. 4-3. Where shown, some of the keys can be used at any time without selecting the normal menu.

OTHER COMMAND CODES

There are command codes which are not appropriate to manual operation. See Table 4-3. Further explanations are given under 'Writing a program'.

There are command codes for measurements and settings. See Table 4-4. Further explanation is given 'Writing a program'.

ASCII CODES

An ASCII character has been allocated to each key. When the command code SK is used, the character's ASCII code is sent. See Fig. 4-4.

SUMMARY

See Table 4-5 for an alphabetical list of command codes.

REMOTE OPERATION

TABLE 4-1 COMMAND CODES FOR NORMAL FUNCTIONS OF KEYS

Key group	Key legend	Function	Command code	Data	
MODE and miscellaneous blue	TX TEST		TX		
	RX TEST		RX		
	DUPLEX TEST		DX		
	TONES		TN		
	TX MON ON-OFF	Display TRANSMITTER MONITOR MODE SELECTION MENU		XE	
	SCOPE/BAR	BAR charts SCOPE		BC SC	
	HOLD DISPLAY	Off or on	HD	0 or 1	
Brown	HELP		HP		
FUNCTION green	AF GEN		AG		
	RX=TX FREQ		RT		
	RF GEN		RG		
	SET MOD		SM		
	ON OFF	Off or on All modulation off or modulation 1 and external modulation on (for compatibility with 2955 MOD ON-OFF)		NF MD	0 or 1 0 or 1
	SINAD S/N and DIST'N ON-OFF	Off, DEFAULT NOISE READING (as under PARAMETERS), non-default reading or DISTORTION		SN	0, 1, 2 or 3
Brown	AC DC	AC	AC		
		DC	DC		
DATA orange	FREQ		FR		
	LEVEL		LV		
	Δ INCR		DI		
	STORE		ST		
	RECALL		RC		
DATA white	Numerical DELETE		As key		
			DE		
FREQ/LEVEL orange	MHz V	MHz	MZ		
		V	VL		
	kHz mV	kHz	KZ		
		mV	MV		
	Hz μV	Hz	HZ		
		μV	UV		
	dB	dB	DB		
		dBμV	BU		
dBm		DM			

Key group	Key legend	Function	Command	Data code
MOD orange	FM AM % ΦM RAD		FM AM PM	
Δ INCREMENT brown	FREQ ↑ FREQ ↓ LEVEL ↑ LEVEL ↓		FU FD LU LD	
AF FILTERS brown	BAND PASS and LOW PASS	0.3 to 3.4 kHz, 15/50 kHz, 300 Hz or external	FI	0, 1, 2 or 3
OSCILLOSCOPE brown	SINGLE REP ◄◄ ◄◄ ◄◄ ◄◄		SW RP TD TU VD VU	
Brown	SELECT ↔	BNC RF IN/OUT, N RF IN/OUT or one-port duplex	IP	0, 1 or 2

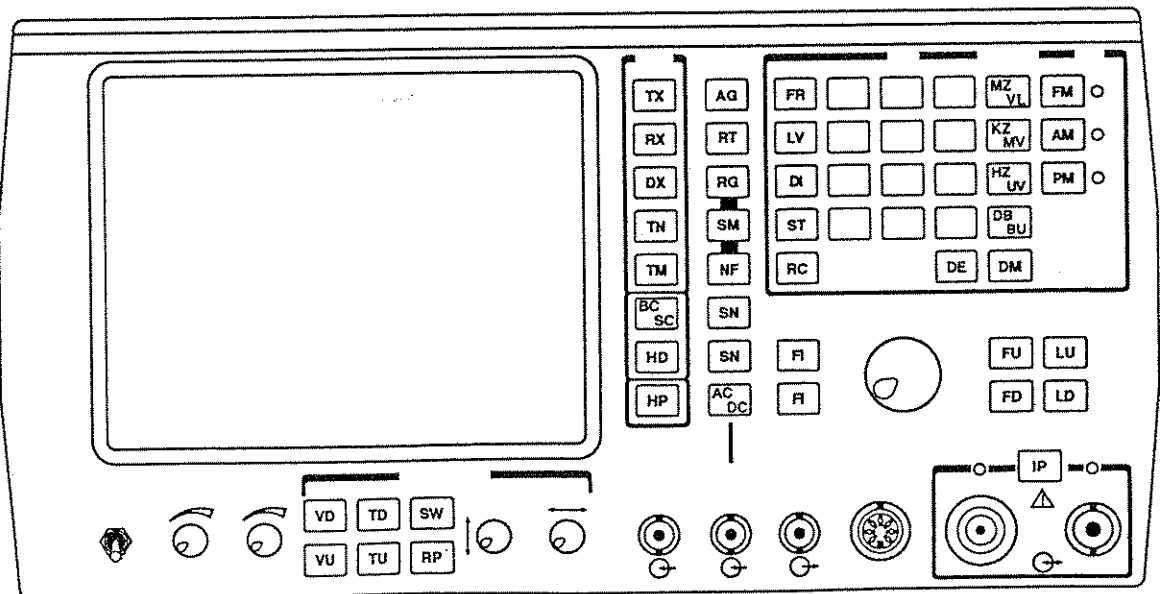

C0287

Fig. 4-2 Command codes for normal functions of keys

TABLE 4-2 COMMAND CODES FOR SOFT-KEY FUNCTIONS

Menus or displays	Function	Command code		
		Normal	Direct	
			Code	Data
TONES	AUDIO SETUP	XA		
	MOD SETUP	XA		
	MOD or AF SETUP	XA		
	SEQUENTIAL	XB		
	SEQUENTIAL ENCODE	XB		
	DTMF	XC		
	DCS	XD		
	SEQUENTIAL DECODE	XD		
	POCSAG	XE		
	RETURN	XG		
TX AUDIO SETUP RX MODULATION SETUP	LOCK or UN-LOCK	XE	LL	1 or 0
	SHAPE	XF	WS	0 (SINE), 1 (SQUARE), 2 (TRIANGLE), or 3 (SAW TOOTH)
	RETURN	XG		
	EXT MOD or OFF	XH		
SEQUENTIAL TONES	CCIR	XA		
	ZVEI	XB		
	DZVEI	XC		
	EEA	XD		
	EIA	XD		
	USER DEFINED	XE		
	REVERTIVE	XF		
	RETURN	XG		
TX SEQUENTIAL TONES	NEXT PAGE	XB		
	RESET or READY	XC		
	RETURN	XG		
RX SEQUENTIAL TONES AF SEQUENTIAL TONES	NEXT PAGE	XA		
	NEXT TONE	XB		
	TONE BURST	XC		
	CONTINUOUS or TONES STOP	XD		
	TONE STEP	XE		
	FREQ SHIFT	XF		
	RETURN	XG		
	EXTEND or CANCEL E	XH		
USER DEFINED STANDARD	NEXT TONE	XB		
	DURATION	XD		
	ms	XE		
	CONTINUE	XF		
	RETURN	XG		
	COPY	XH		

REMOTE OPERATION

Menus or displays	Function	Command code		
		Normal	Direct	
			Code	Data
COPY TONES MENU	CCIR	XA		
	ZVEI	XB		
	DZVEI	XC		
	EEA	XD		
	EIA	XE		
	RETURN	XG		
RX REVERTIVE SEQUENTIAL TONES menu	POWER	XB		
	SEND STANDARD	XC		
	RECEIVE STANDARD	XD		
	CONTINUE	XF		
	RETURN	XG		
RX REVERTIVE SEQUENTIAL TONES display	NEXT TONE	XB		
	SEND	XC		
	CONTINUE	XF		
	RETURN	XG		
	EXTEND or CANCEL E	XH		
DTMF GENERATOR AND DECODER	Send single digits	As key	OD	0 to F
	SEND	XB	SS	
	CLEAR SEND DATA	XC	CT	
	CLEAR RECEIVE DATA	XD	CD	
	LOAD	XE	LS	
	TONE DURATION	XC		
	ms	XD		
	GAP DURATION	XE		
	RETURN	XG		
	PAGE 2 or 1	XH		
DCS DECODER DCS GENERATOR	SEND or STOP	XB		
	POLARITY	XC		
	CODE or ENTER	XD		
	RETURN	XG		
POCSAG RADIO PAGER TEST	INVERT OR NORMAL	XA		
	SEND	XB		
	RIC or ENTER	XC	RI	7 digits
	ERRORS or CHANGE	XD		
	Create		PP	1 to 32
	Delete		PT	1 to 32
	ADDRESS	XF	PA	1, 2, 3 or 4
	RETURN	XG		
	MESSAGE	XH	PS	1, 2, 3 (all languages) or 4 (English only)
HELP	TRANSMITTER TESTING	XA		
	RECEIVER TESTING	XB		
	DUPLEX TESTING	XC		
	AUDIO TESTING	XD		
	CHANGE PARAMETERS	XE		
	SELF TEST	XF		
	RETURN	XG		

REMOTE OPERATION

Menus or displays	Function	Command code		
		Normal	Direct	
			Code	Data
PARAMETERS (Any menu for direct codes)	RF LEVEL EMF or PD	XA	EM	PD
	STORE FUNCTION ON or OFF	XB	SE	SD
	RF COUNTER RESOLUTION 1 Hz or 10 Hz	XC		
	DEFAULT NOISE READING S/N or SINAD	XD		
	600 Ω BALANCED AF ACCESSORY FITTED or NOT FITTED	XE		
	20 dB AF ATTENUATOR ACCESSORY FITTED or NOT FITTED	XF		
	DEFAULT AF FILTER 0.3 - 3.4 kHz BP, 15/50 kHz LP or 300 Hz LP	XA		
	DEFAULT MOD LEVEL	XB		
	RX/TX MOD TYPE LOCK ON or OFF	XC		
	tone STANDARD EUROPEAN or USA	XD		
	RF LEVEL OFFSET	XE		
	GPIB MODE NORMAL or 2955 EMULATION	XF	CM	0 or 1
	RETURN	XG		
	PAGE 2 or 1	XH		
SELF TEST	NEXT TEST	XA		
	ALL TESTS	XF		
	RETURN	XG		
TX MONITOR MODE SELECTION MENU	MANUAL TUNE	XB		
	START + STEP	XC		
	SELECTED FREQS	XD		
	RETURN	XG		
TRANSMITTER MONITOR (MANUAL TUNE)	RF IMAGE UPPER or LOWER	XB	IM	1 or 0
	IF FILTER 12 or 180 kHz	XC	IF	0 or 1
	RETURN	XE		
	LCL	XH		
TX MONITOR START + STEP MENU	DISPLAY CHAN: ON or OFF	XB	CH	1 or 0
	TX START FREQ:	XC		
	TX START CHAN:	XD		
	INCREMENTS:	XE		
	NUMBER OF STEPS:	XF		
	RETURN	XG		
	CONTINUE	XH		

Menus or displays	Function	Command code		
		Normal	Direct	
			Code	Data
TX MONITOR SELECTED FREQS MENU	DISPLAY CHAN: ON or OFF	XB	CH	1 or 0
	NEXT ENTRY	XC		
	CHANGE FREQ	XD		
	CHANGE CHAN	XE		
	INSERT	XF		
	RETURN	XG		
	CONTINUE	XH		
TRANSMITTER MONITOR (START + STEP or SELECTERD FREQS)	SCAN or STOP	XA	FS	1 or 0
	RF IMAGE UPPER or LOWER	XB	IM	1 or 0
	IF FILTER 12 or 180 kHz	XC	IF	0 or 1
	RETURN	XE		
	LCL	XH		
DIRECTIONAL POWER METER (Any menu for direct codes)	PEP or CW	XC	PR or CR	
	LCL	XH		
TRANSMITTER TEST RECEIVER TEST DUPLEX TEST AUDIO TEST				
	LCL	XH		

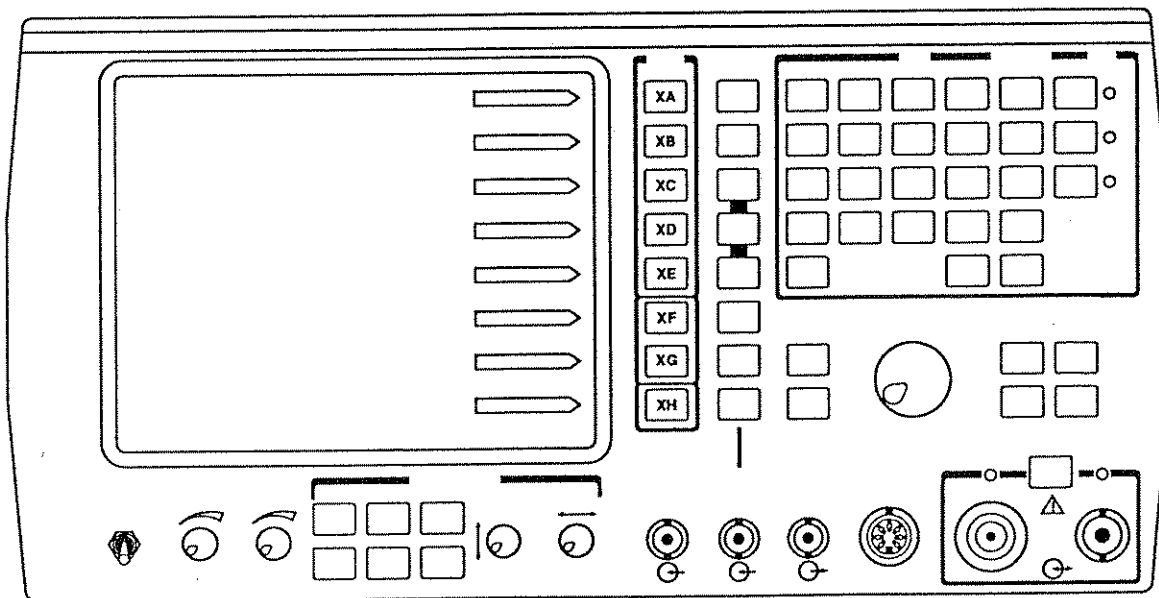

C0288

Fig. 4-3 Command codes for soft-key functions

REMOTE OPERATION

TABLE 4-3 COMMAND CODES FOR NON-MANUAL OPERATION

Function	Command code	Data
DIRECTIONAL POWER METER display disable when Directional Power Head is fitted	DT	
DIRECTIONAL POWER METER display enable when Directional Power Head is fitted	ET	
Output buffer purge (clears data available flag but service request flag remains raised)	PG	
Output from 2955B with letters of mixed case in units (e.g. dBm) (default condition which suits most printers)	LC	
Output from 2955B with all letters of upper case in units (e.g. DBM)	UC	
Output from 2955B having <CR><LF> between readings and <LF> with the GPIB's EOI line true when the output buffer is empty (default condition which suits most controllers)	LF	
Output from 2955B having <CR><LF> with the GPIB's EOI line true between readings and <ETX> with the GPIB's EOI line true when the output buffer is empty	EX	
Poke byte <n> into memory location <m> (includes a 10 ms delay for EEPROMs) (Data cannot be poked to the display since it is not memory mapped - use WR.) Poke bytes <n1>, <n2> etc (up to a terminator) into memory locations starting at <m> (maximum of 64 bytes) (includes a 10 ms delay for EEPROMs)	PO DU	<m>, <n> <m>, <n1>, <n2> ...
(These should not be used except under the supervision of a Marconi Instruments representative.)		
Screen clear	CS	
Screen output disable	DS	
Screen output enable	ES	
Screen restore	RS	
On screen, suppress reverse video REM, ADR and SRQ and soft key legend LCL (This is cleared by RS.)	SP	
On screen, draw soft key box to arrow the key where <n> is the box position and <m> is the box length (number of characters).	BX	<n>, <m>
On screen, write <string> starting at given column and given row (This is followed by delimiter <ETB> <ETX> or <LF>. <CR> has the effect of <CR><LF>.)	WR	0 to 39, 0 to 31, <string>
Service request inhibit (default), error only or enable	SQ	0, 1 or 2
SEQUENTIAL TONES, select FREQUENCY measurements for use with RD 14 to 24 (Table 4-3-4)		TF
SEQUENTIAL TONES, select TONE number and ERROR measurements for use with RD 14 to 24 (Table 4-3-4)		TE
Sound a tone in the loudspeaker (The loudness is determined by the VOLUME control setting.)	BP or PB	
VARIABLE control disable	DV	
VARIABLE control enable	EV	

TABLE 4-4 COMMAND CODES FOR READINGS

Function	Command code	Data
Send (when next addressed to talk) the measurement or setting as specified in <n> as follows:-	RD	<n>
AF counter FREQUENCY measurement		5
AF GENERATOR FREQUENCY INCREMENT setting		35
AF GENERATOR FREQUENCY setting		29
AF GENERATOR LEVEL INCREMENT setting		36
AF GENERATOR LEVEL setting		30
AF GENERATOR 2 FREQUENCY setting		100
AF GENERATOR 2 LEVEL setting		101
AF LEVEL measurement in dBV or dBr		104
AF LEVEL voltage measurement		6
DIRECTIONAL POWER METER FORWARD POWER measurement		11
DIRECTIONAL POWER METER REVERSE POWER measurement		12
DIRECTIONAL POWER METER VSWR measurement		13
DTMF RECEIVE DATA		109
MODULATION FREQUENCY INCREMENT setting		37
MODULATION FREQUENCY measurement		3
MODULATION FREQUENCY setting		31
MODULATION LEVEL default setting		106
MODULATION LEVEL INCREMENT setting		38
MODULATION LEVEL measurement in dB		105
MODULATION LEVEL voltage measurement		4
MODULATION LEVEL setting		32
MODULATION LEVEL peak positive measurement		9
MODULATION LEVEL trough negative measurement		10
MODULATION 2 FREQUENCY setting		102
MODULATION 2 LEVEL setting		103
POCSAG RIC setting		108
RECEIVER SINAD, S/N or DISTORTION measurement		7
RF counter FREQUENCY measurement		1
RF GENERATOR FREQUENCY INCREMENT setting		33
RF GENERATOR FREQUENCY setting		27
RF GENERATOR LEVEL INCREMENT setting		34
RF GENERATOR LEVEL setting		28
RF POWER measurement in W or dBm		2
SEQUENTIAL TONES DURATION in ms setting		107
SEQUENTIAL TONES, current PAGE number		25
SEQUENTIAL TONES, standard setting		26
SEQUENTIAL TONES, TONE 1) FREQUENCY measurement		14
SEQUENTIAL TONES, TONE 2) or TONE number and		15
SEQUENTIAL TONES, TONE 3) ERROR measurement as		16
SEQUENTIAL TONES, TONE 4) determined by using		17
SEQUENTIAL TONES, TONE 5) TF or TE		18
SEQUENTIAL TONES, TONE 6) (Table 4-3-3)		19
SEQUENTIAL TONES, TONE 7)		20
SEQUENTIAL TONES, TONE 8)		21
SEQUENTIAL TONES, TONE 9)		22
SEQUENTIAL TONES, TONE 10)		23
SEQUENTIAL TONES, TONE 11)		24
TRANSMITTER MONITOR mode CHANNEL number		112
TRANSMITTER MONITOR mode SCAN status (0 for stopped, 1 for scanning)		111
TRANSMITTER MONITOR mode SQUELCH status (0 for demodulation meter outputs disabled, 1 for demodulation meter outputs enabled)		110

REMOTE OPERATION

Function	Command code	Data
TRANSMITTER SINAD, S/N or DISTORTION measurement Whole page of measurements and settings (TRANSMITTER TEST, RECEIVER TEST and DUPLEX tests only)	RD	<n> 8 39
Send (when next addressed to talk) an ASCII code for the character of the last key pressed - see Fig. 4-3	SK	
Send (when next addressed to talk) the code for the last error detected	ER	
Send (when next addressed to talk) the data at memory location <m> (This should not be used except under the supervision of a Marconi Instruments representative.)	PE	<m>
Send (when next addressed to talk) a data string which, when sent back to the instrument, restores current settings	SV	
Send (when next addressed to talk) the software version number (A 2955B is distinguished from a 2955 by having a version number above 100.)	VN	

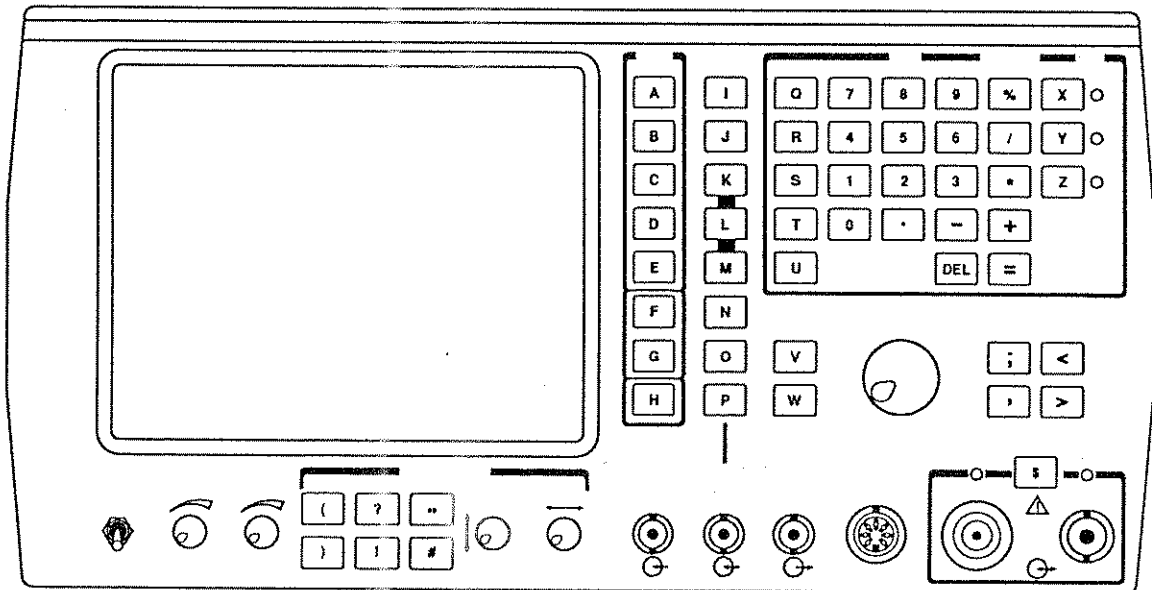

C0289

Fig. 4-4 ASCII characters sent when the SK command code is used

TABLE 4-5 SUMMARY OF COMMAND CODES

Command code	Data	Function
AC		As AC DC key - AC selected
AG		As AF GEN key
AM		As AM % key
BC		As SCOPE/BAR key - BAR charts selected
BP		Sound a tone in the loudspeaker
BU		As dB key - dB μ V selected
BX	<n>, <m>	On screen, draw soft key box to arrow the key where <n> is the box position and <m> is the box length (number of characters)
CD		CLEAR DTMF RECEIVE DATA
CH	1 or 0	TRANSMITTER MONITOR mode DISPLAY CHANNEL ON or OFF
CM	0 or 1	NORMAL 2955A or 2955 EMULATION (under any menu)
CR		Select CW for DIRECTIONAL POWER METER (under any menu)
CS		Screen clear
CT		CLEAR DTMF SEND DATA
DB		As dB key - dB selected
DC		As AC DC key - DC selected
DE		As DELETE key
DI		As Δ INCR key
DM		As dBm key
DS		Screen output disable
DT		DIRECTIONAL POWER METER display disable when Directional Power Head is fitted
DU	<m>, <n1>, <n2> ...	Poke bytes <n1>, <n2> etc (up to a terminator) into memory locations starting at <m> (maximum of 64 bytes)
DV		VARIABLE control disable
DX		As DUPLEX TEST key
EM		Set instrument to EMF measurement (under any menu)
ER		Send (when next addressed to talk) the code for the last error detected
ES		Screen output enable
ET		DIRECTIONAL POWER METER display enable when Directional Power Head is fitted
EV		VARIABLE control enable
EX		Send <EOI><ETX> when the output buffer is empty
FD		As FREQ \downarrow key
FI	0, 1, 2 or 3	As BAND PASS and LOW PASS keys - 0.3 to 3.4 kHz BP, 15/50 kHz LP, 300 Hz or external selected
FM		As FM key
FR		As FREQ key
FS	1 or 0	TRANSMITTER MONITOR mode SCAN or STOP
FU		As FREQ \uparrow key
HD	0 or 1	As HOLD DISPLAY key - off or on
HP		As HELP key
HZ		As Hz μ V key - Hz selected
IF	0 or 1	TRANSMITTER MONITOR mode IF filter 12 kHz or 180 kHz
IM	0 or 1	TRANSMITTER MONITOR mode RF IMAGE UPPER or LOWER
IP	0, 1 or 2	As SELECT \leftrightarrow key - BNC RF IN/OUT, N RF IN/OUT or

REMOTE OPERATION

Command code	Data	Function
KZ		As kHz mV key - kHz selected
LC		Letters mixed case to be used in terminator strings (e.g. dBm)
LD		As LEVEL ↓ key
LF		Send <EOI> with <LF>
LL	1 or 0	LOCK or UN-LOCK modulation or AF levels together
LS		LOAD DTMF tones sequence
LU		As LEVEL ↑ key
LV		As LEVEL key
MD	0 or 1	As ON OFF key - all modulation off or modulation 1 and external external modulation on (for compatibility with 2955 MOD ON-OFF)
MV		As kHz mV key - mV selected
MZ		As MHz V key - MHz selected
NF	0 or 1	As ON OFF key - off or on
OD	0 to F	Send single DTMF digits
PA	1, 2, 3 or 4	Set POCSAG ADDRESS
PB		Sound a tone in the loudspeaker
PD		Set instrument to PD measurement (under any menu)
PE	<m>	Send (when next addressed to talk) the data at memory location <m>
PG		Purge output buffer
PM		As ΦM RAD key
PO	<m>, <n>	Poke byte <n> into memory location <m>
PP	1 to 32	Create POCSAG ERRORS
PR		Select PEP for DIRECTIONAL POWER METER (under any menu)
PS	1, 2, 3 or 4	Set POCSAG MESSAGE
PT	1 to 32	Delete POCSAG ERRORS
RC		As RECALL key

Command code	Data	Function
RD	<n>	Send (when next addressed to talk) the measurement or setting as specified in <n> as follows:-
	1	RF counter FREQUENCY measurement
	2	RF POWER measurement
	3	MODULATION FREQUENCY measurement
	4	MODULATION LEVEL voltage measurement
	5	AF counter FREQUENCY measurement
	6	AF LEVEL voltage measurement
	7	RECEIVER SINAD, S/N or DISTORTION measurement
	8	TRANSMITTER SINAD, S/N or DISTORTION measurement
	9	MODULATION LEVEL peak positive measurement
	10	MODULATION LEVEL trough negative measurement
	11	DIRECTIONAL POWER METER FORWARD POWER measurement
	12	DIRECTIONAL POWER METER REVERSE POWER measurement
	13	DIRECTIONAL POWER METER VSWR measurement
	14	SEQUENTIAL TONES, TONE 1) FREQUENCY measurement
	15	SEQUENTIAL TONES, TONE 2) or TONE number and
	16	SEQUENTIAL TONES, TONE 3) ERRORS measurement as
	17	SEQUENTIAL TONES, TONE 4) determined by using
	18	SEQUENTIAL TONES, TONE 5) TF or TE
	19	SEQUENTIAL TONES, TONE 6) (Table 2-3)
	20	SEQUENTIAL TONES, TONE 7)
	21	SEQUENTIAL TONES, TONE 8)
	22	SEQUENTIAL TONES, TONE 9)
	23	SEQUENTIAL TONES, TONE 10)
	24	SEQUENTIAL TONES, TONE 11)
	25	SEQUENTIAL TONES, current PAGE number
	26	SEQUENTIAL TONES, standard setting
	27	RF generator FREQUENCY setting
	28	RF generator LEVEL setting
	29	AF GENERATOR FREQUENCY setting
	30	AF GENERATOR LEVEL setting
	31	MODULATION FREQUENCY setting
	32	MODULATION LEVEL setting
	33	RF FREQUENCY INCREMENT setting
	34	RF LEVEL INCREMENT setting
	35	AF GENERATOR FREQUENCY INCREMENT setting
	36	AF GENERATOR LEVEL INCREMENT setting
	37	MODULATION FREQUENCY INCREMENT setting
	38	MODULATION LEVEL INCREMENT setting
	39	Whole page of measurements and settings (TRANSMITTER TEST, RECEIVER TEST and DUPLEX tests only)
	100	AF GENERATOR 2 FREQUENCY setting
	101	AF GENERATOR 2 LEVEL setting
	102	MODULATION 2 FREQUENCY setting
	103	MODULATION 2 LEVEL setting
	104	AF LEVEL measurement in dBV or dBr
	105	MODULATION LEVEL measurement in dB
	106	MODULATION LEVEL default setting
	107	SEQUENTIAL TONES DURATION in ms setting
	108	POCSAG RIC setting
	109	DTMF RECEIVE DATA
	110	TRANSMITTER MONITOR mode SQUELCH status (0 for demodulation meter outputs disabled, 1 for demodulation meter outputs enabled)
	111	TRANSMITTER MONITOR mode SCAN status (0 for stopped, 1 for scanning)
	112	TRANSMITTER MONITOR mode CHANNEL number

REMOTE OPERATION

Command	Data	Function
RG		As RF GEN key
RI	7 digits	Set POCSAG RIC
RP		As REP key
RS		Screen restore
RT		As RX=TX FREQ key
RX		As RX TEST key
SC		As SCOPE/BAR key - SCOPE selected
SD		Store disable and POke disable (under any menu)
SE		Store enable and POke enable (under any menu)
SK		Send (when next addressed to talk) an ASCII code for the character of the last key pressed - see Fig. 4-3
SM		As SET MOD key
SN	0, 1, 2 or 3	As SINAD S/N and DIST'N ON-OFF keys - off, default (SINAD or S/N), non-default (S/N or SINAD) or DISTORTION
SP		On screen, suppress annunciators REM, ADR, SRQ and LCL
SQ	0, 1 or 2	Service request inhibit, error only or enable
SS		SEND DTMF tones sequence
SV		Send (when next addressed to talk) a data string which, when sent back to the instrument, restores current settings
ST		As STORE key
SW		As SINGLE key
TD		As ↔ key
TE		SEQUENTIAL TONES, select TONE number and ERROR measurements for use with RD 14 to 24 (Table 2-4)
TF		SEQUENTIAL TONES, select FREQUENCY measurements for use with RD 14 to 24 (Table 2-4)
TM	0 or 1	As TX MON ON-OFF key off or on
TN		As TONES key
TU		As →← key
TX		As TX TEST key
UC		Letters upper case only to be used in terminator strings (e.g. DBM)
UV		As Hz μV key - μV selected
VD		As ↑↓ key
VL		As MHz V key - V selected
VN		Send (when next addressed to talk) the software version number
VU		As ↓↑ key
WR	0 to 39, 0 to 31, <string>	Write <string> starting at given column and given row
WS	0, 1, 2 or 3	Wave SHAPE - SINE, SQUARE, TRIANGLE or SAW TOOTH
XA		As TX TEST key as soft key
XB		As RX TEST key as soft key
XC		As DUPLEX TEST key as soft key
XD		As TONES key as soft key
XE		As TX MON ON-OFF key as soft key
XF		As SCOPE/BAR key as soft key
XG		As HOLD key as soft key
XH		As HELP key as soft key

Writing a program

OPERATING EXAMPLE

RX;RG;FR123.5MZ;DI100KZ;LV-30DM;SM;FR1KZ;LV50AM;NF1;AC;SN2<LF>
is an example of a composite statement which has the following meaning:-

Statement	Key equivalent	Explanation
RX;	RX TEST	In RECEIVER TEST mode,
RG;	RF GEN	set the RF generator
FR	FREQ	frequency
123.5MZ;	125.5 MHz	to 123.5 MHz,
DI	Δ INCR	set the increment
100KZ;	100 kHz	to 100 kHz,
LV	LEVEL	set the RF level
-30DM;	-30 dBm	to -30 dBm,
SM;	SET MOD	set the modulation
FR	FREQ	frequency
1KZ;	1 kHz	to 1 kHz,
LV	LEVEL	set the modulation level
50AM;	50 AM %	to 50% AM and,
NF1;	ON OFF	with modulation on,
AC;	AC DC	set to AC coupling and
SN2	SINAD S/N	measure signal to noise
<LF>		

The above example is equivalent to a normal sequence of keys except as follows:-

- NF1 is a direct entry without knowing the existing state.
- AC is a direct entry without knowing the existing state.
- SN2 is a direct entry on the assumption that SINAD is the DEFAULT NOISE READING selection under PARAMETERS.

GPIB CONTROLLER PROGRAMS

On the controller, set the 2955B to remote control and enter 2955B commands within quotation marks (e.g. OUTPUT 706,"RX" <LF>). In this example, the number indicates the controller's GPIB port (i.e. 7) and the 2955B's address (i.e. 06). REM and ADR appear in reverse video on high-level displays. Also, the soft key arrow LCL (local) appears.

To return to local manual control, press the LCL key.

On the controller, you can request data from the 2955B when it has completed measurements or for any other reason (e.g. ENTER 706;A\$ <LF> and say PRINT A\$ <LF>).

COMPUTER PROGRAMS

When using a computer and the EIA-232 (formerly RS-232) interface standard, ensure that a suitable NULL modem is fitted. Check that the parameters match those of the 2955B.

After switching on, check that ADR appears in reverse video on the display to indicate that the 2955B is ready to listen.

The exact method of sending and receiving data depends on the programming language which is used. Refer to the documentation for the programming language.

COMMAND INPUT

If the 2955B detects a syntax error, then that command and all subsequent commands up to the next low-priority delimiter are aborted and an error is raised.

The 2955B's input buffer length is 128 characters. If the buffer becomes full, then the GPIB is held off until further space is available. However, if the buffer does not contain a command delimiter, then the data is lost and an error is raised. This is because command interpretation, and hence buffer unloading, does not occur until a command string delimiter is received.

DATA OUTPUT

Every request for data causes a response from the instrument. This takes the following form:-

<data> [<data type>] <delimiter>

where <data> contains the reading

and <data type> is an ASCII string when the data requires qualifying (e.g. MHz and dBm).

The data may be a numerical or alpha string. There is no fixed format except that numerical data conforms to NR1 or NR2 data types (i.e. non-exponential).

All readings are terminated with <LF>. The GPIB bus EOI line is sent true when the output buffer is empty.

If no data is available, the default response is NULL.

Certain commands cause the instrument to output more data than it can store in its output buffer (e.g. SV and RD39). The result is that the data is held off from entering the buffer and hence the instrument stops. To prevent locking up the instrument, a 2 second timeout takes effect. If data output has not been started or is read out slower than 1 character per 2 seconds, then a buffer overflow error is raised and the instrument aborts the command.

STATUS BYTE AND SERVICE REQUESTS

In the instrument, there is one status byte which contains the following bits:-

Byte	Function
1xxxxxxx	Data ready
x1xxxxxx	Service request
xx1xxxxx	An error bit is high
xxx1xxxx	Numerical entry error (error bit 4)
xxxx1xxx	Data error (error bit 3)
xxxxx1xx	Abnormal operation (error bit 2)
xxxxxx1x	Syntax error (error bit 1)
xxxxxxx1	Input/output buffer overflow (error bit 0)

When the 2955B's service request is enabled by means of SQ1 or SQ2, it can send the status byte when the controller takes a serial poll (e.g. SPOLL (706) <LF>). After SQ1, the service request bit is high only when an error bit is high. After SQ2, the service request bit is high when an error bit or the data ready bit is high.

When the service request bit is high, SRQ appears in reverse video on high-level displays and the GPIB's SRQ line is true.

The data ready and error bits are cleared the next time the instrument is addressed to talk. The service request bit is cleared after a serial poll.

CREATING A SCREEN DISPLAY

A GPIB controller can be used to create your own form of screen display. The 2955B has a number of screen commands and it has a comprehensive character set stored in memory.

Screen commands

Using the command codes which are listed in Table 2-3, create your own display as follows:-

- (a) Use CS to clear the current display from the screen.
- (b) Use WR and BX to define your own display.

When CS is used, measurements remain on the screen. Use DS to stop measurements (disable) from being shown on the screen and use ES to write measurements (enable) on the screen.

WR (WRite) commands

These are used to write characters on the screen display. The command code WR is followed by the start location and then the characters which are to be written.

The start address takes the form <c>,<r>, where <c> is the column number and the <r> is the row number as shown on the worksheet which is given in Fig. 4-5. This can be copied and used for plotting.

Anything immediately following WR<c>,<r>, is treated as a literal until a high-priority delimiter is seen. Thus, when there is more than one WR command in a statement, end each with <LF>, <CR> (moving the cursor to the beginning of the next line), <ETB> or <ETX> (e.g. WR20,15,A <LF> WR20,16,B <LF>) and do not only insert a delimiter at the end (e.g. not WR20,15,A,WR,20,16,B<LF>). In a controller statement, CHR\$(10) would be used for <LF> (e.g. OUTPUT706;"WR20,15,A";CHR\$(10);"WR20,16,B";CHR\$(10)).

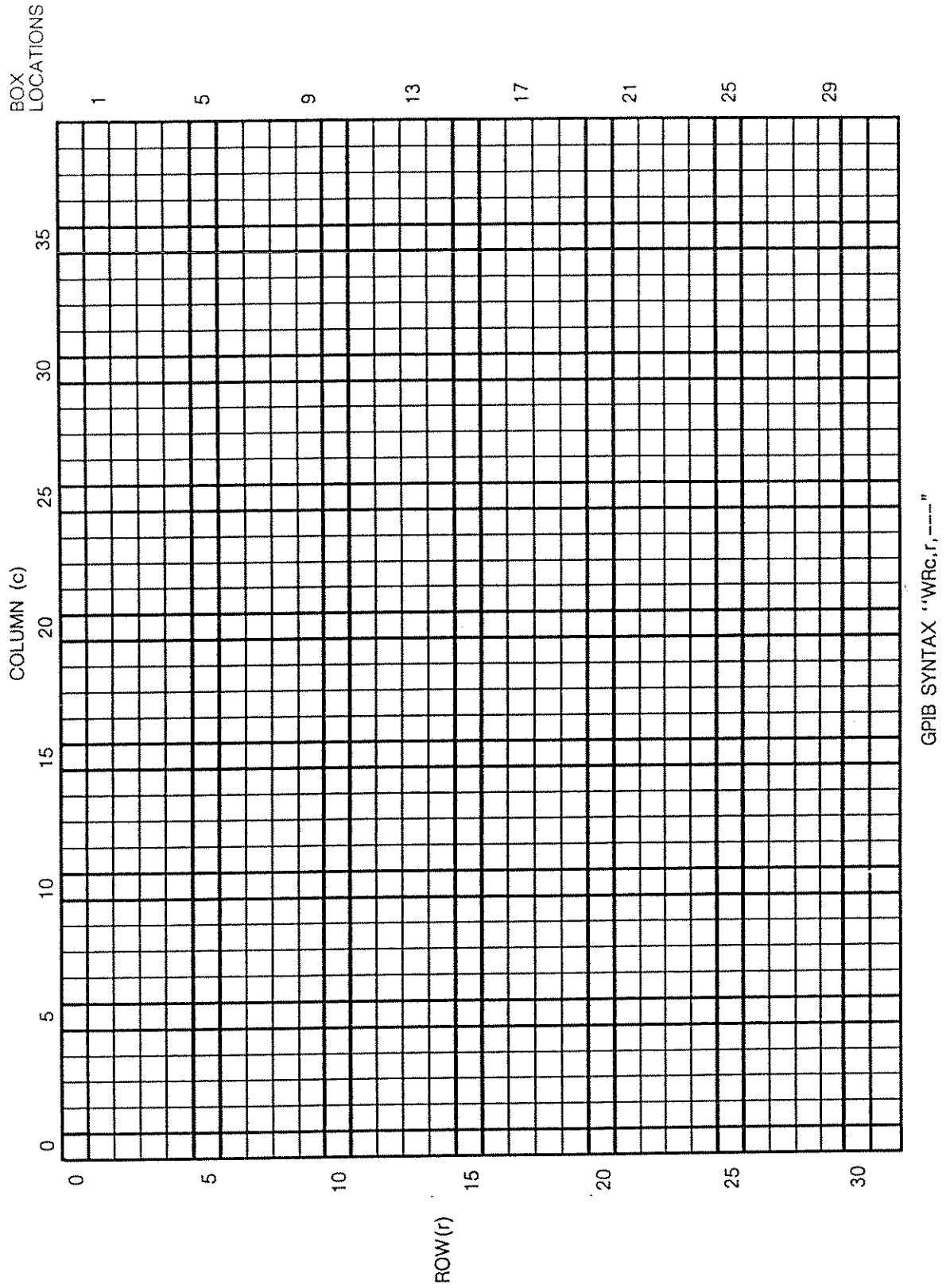

Fig. 4-5 Screen address worksheet

Character set

For the complete set of characters for the instrument, see Table 4-6 and Fig. 4-6. These characters are used with the WR command to write onto the screen display. In addition to alphanumerical characters A to Z and 0 to 9, there are elements to make graphics, oscilloscope graticules and bar charts.

With the principal exception of the alphanumerical characters A to Z and 0 to 9, the characters are non-ASCII. There are two ways to enter non-ASCII characters - either use the code or enter the ASCII equivalent (e.g. for $k\Omega$, use "WR10,10,;"CHR\$(41);CHR\$(38) or "WR10,10,)&"). When a lower case letter (ASCII) is sent from the controller, it is interpreted by the 2955B as a reverse video upper-case letter.

For codes 3, 10, 13 and 23, blanks are shown on Fig. 4-6. These codes are for <ETX>, <LF>, <CR> and <ETB>. As codes 3 and 10 are not available for reverse video 0 and 7, codes 2 and 19 are used instead. A reverse video z can be seen on the CHANGE PARAMETERS menu but it is only available to internal software and not from the GPIB.

Table 4-6 and Fig. 4-6 are for normal operation. For 2955 emulation, there is one difference - the character for code 125 (reverse video /) is not as shown but is the same as the box element for code 63.

Reverse video characters

For characters which have a bar at the top (i.e. E, F, T and Z), a better appearance can be given by writing a reverse video top character (code 59) directly above it (e.g. "WR10,15,e" for a reverse video E with "WR10,14,;"CHR\$(59) or "WR10,14,;" for a reverse video top character).

TABLE 4-6 CHARACTER CODES

Code		2955B character	ASCII	Code		2955B character	ASCII
dec	hex			dec	hex		
0	0	- (Reverse video)		48	30	0	0
1	1	. (Reverse video)		to	to	to	to
2	2	0 (Reverse video)		57	39	9	9
3	3	<ETX>	<ETX>	58	3A	:	:
4	4	1		59	3B	Reverse video top	:
to	to	to		60	3C	Graphics element	<
9	9	6 (Reverse video)		61	3D	'	=
10	A	<LF>	<LF>	62	3E	Graphics element	>
11	B	8 (Reverse video)		63	3F	Graphics element	?
12	C	9 (Reverse video)		64	40	Graphics element	@
13	D	<CR>	<CR>	65	41	A	A
14	E	Arrow symbol		to	to	to	to
15	F	* (Reverse video)		90	5A	Z	Z
16	10	Ω (Reverse video)		91	5B	Graphics element	[
17	11	# (Reverse video)		92	5C	Graphics element	\
18	12	*		93	5D	>]
19	13	7 (Reverse video)		94	5E	Graphics element	^
20	14	\$		95	5F	Graphics element	-
21	15	#		96	60	Pointer symbol	'
22	16	Bell symbol		97	61	A	a
23	17	<ETB>	<ETB>	to	to	to	to
24	18	?		122	7A	Z (Reverse video)	z
25	19	@		123	7B	Graphics element	{
26	1A	Copyright symbol		124	7C	Graphics element	
27	1B	Graphics element		125	7D	/ (Reverse video)	-
28	1C	<		126	7E	↓	-
29	1D	[127	7F	↑	-
30	1E]		128	80		
31	1F	Space (Reverse video)		to	to		
32	20	Space	Space	191	BF	Graticule elements	
33	21	s	!	192	C0	Graphics element (Flashing)	
34	22	z	"	193	C1	A	
35	23	_ (Underline)	#	to	to	to	
36	24	μ	\$	218	DA	Z (Flashing)	
37	25	%	%	219	DB		
38	26	Ω	&	to	to		
39	27	m	'	223	DF	Graphics elements (Flashing)	
40	28	d	(224	E0		
41	29	k)	to	to		
42	2A	Φ	*	255	FF	Bar chart elements	
43	2B	+	+				
44	2C	,	,				
45	2D	-	-				
46	2E	.	.				
47	2F	/	/				

REMOTE OPERATION

	-0	-1	-2	-3	-4	-5	-6	-7	-8	-9	-A	-B	-C	-D	-E	-F
0-	—	.	0	1	2	3	4	5	6	7	8	9	*	#	+	=
1-	!	@	#	\$	%	&	'	()	*	+	,	-	.	/	:
2-	;	<	=	>	?	@	A	B	C	D	E	F	G	H	I	J
3-	K	L	M	N	O	P	Q	R	S	T	U	V	W	X	Y	Z
4-	[\]	^	_	`	{		}	~	`	`	`	`	`	`
5-	`	`	`	`	`	`	`	`	`	`	`	`	`	`	`	`
6-	`	`	`	`	`	`	`	`	`	`	`	`	`	`	`	`
7-	`	`	`	`	`	`	`	`	`	`	`	`	`	`	`	`
8-	`	`	`	`	`	`	`	`	`	`	`	`	`	`	`	`
9-	`	`	`	`	`	`	`	`	`	`	`	`	`	`	`	`
A-	`	`	`	`	`	`	`	`	`	`	`	`	`	`	`	`
B-	`	`	`	`	`	`	`	`	`	`	`	`	`	`	`	`
C-	`	`	`	`	`	`	`	`	`	`	`	`	`	`	`	`
D-	`	`	`	`	`	`	`	`	`	`	`	`	`	`	`	`
E-	`	`	`	`	`	`	`	`	`	`	`	`	`	`	`	`
F-	`	`	`	`	`	`	`	`	`	`	`	`	`	`	`	`

Fig. 4-6 Character set for 2955B

Graticule elements

There are sixty-four graticule elements for oscilloscope displays (codes 128 to 191).

When two or more graticule elements are adjacent in a vertical line, the oscilloscope trace is automatically enabled. Enabling starts from half-way down the top element to half-way down the bottom element. The oscilloscope trace is not enabled for a single element or for alternate elements in a vertical line. For a space with the trace enabled, it is necessary to use code 128 and not code 32.

If these elements are used for other purposes in a user-defined display, the oscilloscope trace could cause peculiar effects. To detect the presence of a trace, check for any movement while adjusting the POSITION controls.

BX (BoX) commands

These are used to draw arrowed boxes for the functions of soft keys. The command code BX is followed by data <n> and <m>.

The box positions data <n> is the decimal equivalent of the 8-digit binary number which indicates by 1 or 0 which of the eight keys have a box or no box alongside. The eight bits (reading left to right) are for the boxes in rows 29, 25, 21, 17, 13, 9, 5 and 1 respectively. Thus, for a box or no box alongside each key, <n> is the sum of the following decimal data:-

Row	Key	Decimal data
1	TX TEST	1 or 0
5	RX TEST	2 or 0
9	DUPLEX TEST	4 or 0
13	TONES	8 or 0
17	Unmarked (2955B)	
	TX MON ON-OFF (Option 1)	16 or 0
21	SCOPE/BAR	32 or 0
25	HOLD DISPLAY	64 or 0
29	HELP	128 or 0

The length data <m> is the maximum number of characters in the box. The actual total length is 3 more than this - 1 for the left side and 2 for the arrow. When boxes of different lengths are required, sequential BX commands have to be sent.

Thus, to display SELECT in a box of total length 10 alongside the SCOPE/BAR key, use BX32,7;WR31,21,SELECT<LF>).

Since CONTINUE and RETURN are commonly used for menu displays, the facility exists to call up these labels directly by adding fixed values to <m>. The positions for these are fixed - CONTINUE alongside the SCOPE/BAR key and RETURN alongside the HOLD DISPLAY key). This replaces a WR command.

REMOTE OPERATION

To call up the CONTINUE box, add 32 to <m>. Ensure that there is sufficient room for the word in the box (i.e. $32 + \geq 8 = \geq 40$), otherwise CONTINUE cannot be included. Thus, to display CONTINUE in a box of total length 11 alongside the SCOPE/BAR key, the command is BX32,40<LF>.

To call up the RETURN box, add 128 to <m>. Ensure that there is sufficient room for the word in the box (i.e. $128 + \geq 6 = \geq 134$), otherwise RETURN cannot be included. Thus, to display RETURN in a box of total length 9 alongside the HOLD DISPLAY key, the command is BX64,134<LF>.

To clear the screen prior to the boxes being displayed, add 64 to <m>.

User-defined display examples

To write a reverse video A at the centre of the screen at column 20, row 15, use "WR20,15,;"CHR\$(97) or "WR20,15,a". To write SELECT in the box alongside the SCOPE/BAR key, use BX32,6;WR32,21,SELECT<LF>. See Fig. 4-7.

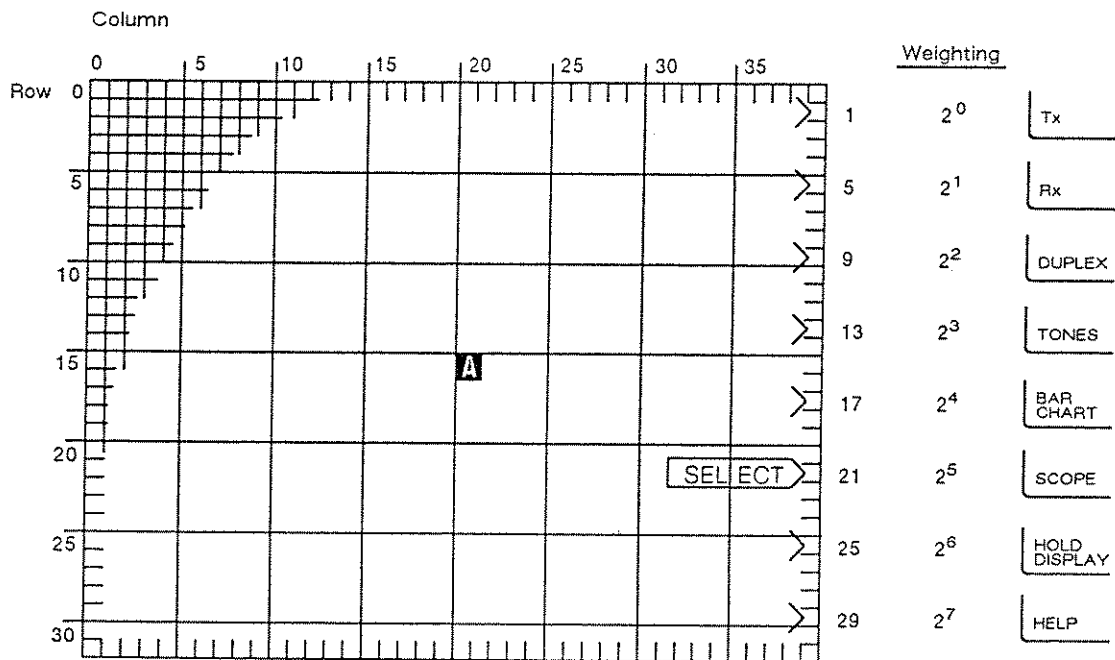

Fig. 4-7 Screen addressing example

A typical application of a user-created display is shown in Fig. 4-8 which features an interconnection diagram.

Graticule elements

There are sixty-four graticule elements for oscilloscope displays (codes 128 to 191).

When two or more graticule elements are adjacent in a vertical line, the oscilloscope trace is automatically enabled. Enabling starts from half-way down the top element to half-way down the bottom element. The oscilloscope trace is not enabled for a single element or for alternate elements in a vertical line. For a space with the trace enabled, it is necessary to use code 128 and not code 32.

If these elements are used for other purposes in a user-defined display, the oscilloscope trace could cause peculiar effects. To detect the presence of a trace, check for any movement while adjusting the POSITION controls.

BX (BoX) commands

These are used to draw arrowed boxes for the functions of soft keys. The command code BX is followed by data <n> and <m>.

The box positions data <n> is the decimal equivalent of the 8-digit binary number which indicates by 1 or 0 which of the eight keys have a box or no box alongside. The eight bits (reading left to right) are for the boxes in rows 29, 25, 21, 17, 13, 9, 5 and 1 respectively. Thus, for a box or no box alongside each key, <n> is the sum of the following decimal data:-

Row	Key	Decimal data
1	TX TEST	1 or 0
5	RX TEST	2 or 0
9	DUPLEX TEST	4 or 0
13	TONES	8 or 0
17	Unmarked (2955B)	
21	TX MON ON-OFF (Option 1)	16 or 0
25	SCOPE/BAR	32 or 0
29	HOLD DISPLAY	64 or 0
	HELP	128 or 0

The length data <m> is the maximum number of characters in the box. The actual total length is 3 more than this - 1 for the left side and 2 for the arrow. When boxes of different lengths are required, sequential BX commands have to be sent.

Thus, to display SELECT in a box of total length 10 alongside the SCOPE/BAR key, use BX32,7;WR31,21,SELECT<LF>).

Since CONTINUE and RETURN are commonly used for menu displays, the facility exists to call up these labels directly by adding fixed values to <m>. The positions for these are fixed - CONTINUE alongside the SCOPE/BAR key and RETURN alongside the HOLD DISPLAY key). This replaces a WR command.

REMOTE OPERATION

To call up the CONTINUE box, add 32 to <m>. Ensure that there is sufficient room for the word in the box (i.e. $32 + \geq 8 = \geq 40$), otherwise CONTINUE cannot be included. Thus, to display CONTINUE in a box of total length 11 alongside the SCOPE/BAR key, the command is BX32,40<LF>.

To call up the RETURN box, add 128 to <m>. Ensure that there is sufficient room for the word in the box (i.e. $128 + \geq 6 = \geq 134$), otherwise RETURN cannot be included. Thus, to display RETURN in a box of total length 9 alongside the HOLD DISPLAY key, the command is BX64,134<LF>.

To clear the screen prior to the boxes being displayed, add 64 to <m>.

User-defined display examples

To write a reverse video A at the centre of the screen at column 20, row 15, use "WR20,15,";CHRS(97) or "WR20,15,a". To write SELECT in the box alongside the SCOPE/BAR key, use BX32,6;WR32,21,SELECT<LF>. See Fig. 4-7.

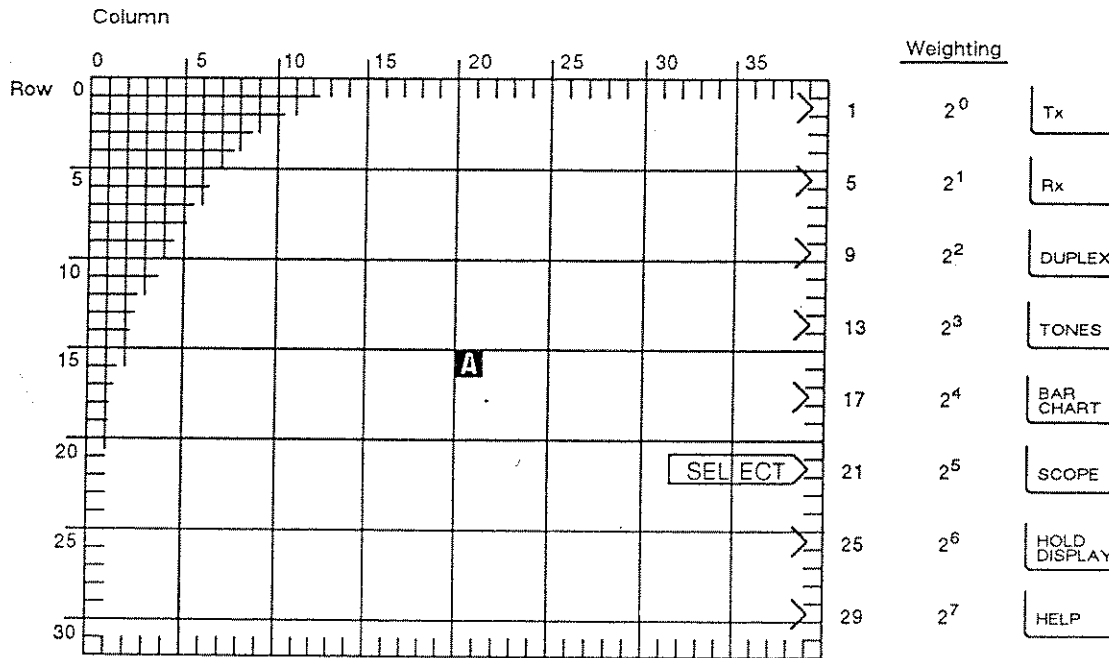

Fig. 4-7 Screen addressing example

A typical application of a user-created display is shown in Fig. 4-8 which features an interconnection diagram.

Chapter 5

BRIEF TECHNICAL DESCRIPTION

	Page
INTRODUCTION	5-1
RF SIGNAL GENERATOR... ..	5-2
AF VOLTMETER	5-3
AF GENERATORS	5-4
RF POWER METER	5-5
MODULATION METER	5-6
DISTORTION AND NOISE METER	5-8
SENSITIVE RECEIVER	5-10

INTRODUCTION

The RF signal generator, the AF voltmeter, the AF generators, the RF power meter, the modulation meter, the distortion and noise meter and the sensitive receiver are each described in this chapter. The counters and the oscilloscope are not included as their construction does not affect the operation of the instrument. The signalling codes tests are not included as they are mainly implemented in software.

RF SIGNAL GENERATOR

A simplified block diagram is shown in Fig. 5-1.

Three voltage controlled oscillators are phase locked to a 10 MHz reference so that they operate with a synthesizer to provide an output in the range 400 kHz to 1000 MHz. The generator can be amplitude modulated, frequency modulated or phase modulated. The internal modulating signal is derived from the AF generators. An external audio signal can be applied to the EXT MOD INPUT socket to add to the internal modulating signal.

The output frequency can be set in steps of 50 or 100 Hz. The output level can be set in steps of 0.1 dB. Using the HELP key, the output level can be selected as EMF (unloaded) or PD (loaded). The maximum output to the BNC socket is 400 mV and to the N socket, through a 20 dB attenuator, is 40 mV.

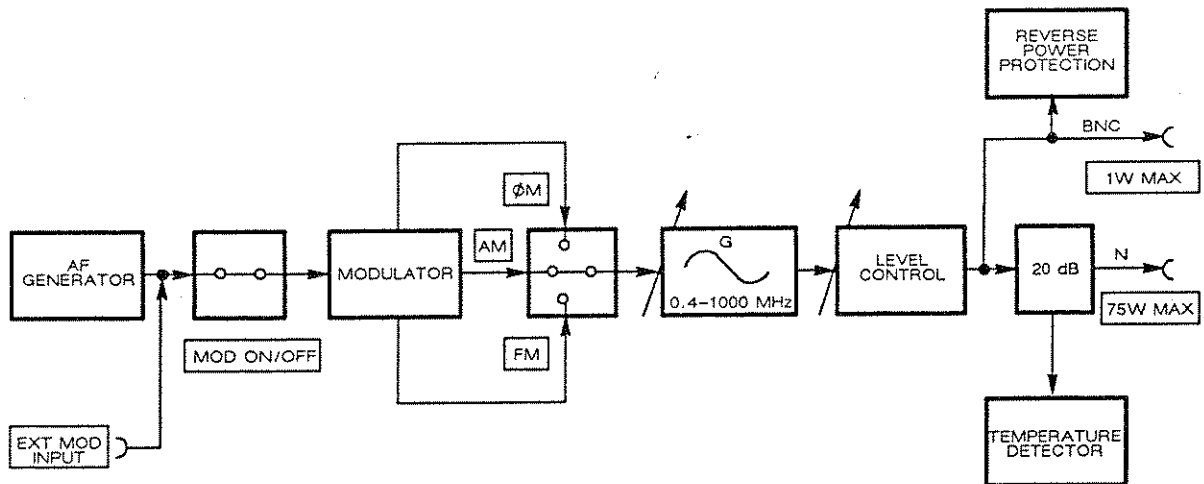

Fig. 5-1 RF signal generator block diagram

AF VOLTMETER

A simplified block diagram is shown in Fig. 5-2.

The AF voltmeter measures an input in the ranges 20 Hz to 50 kHz and 0 to 100 V applied to the AF INPUT socket. The AC/DC key is used to switch in and out a capacitor so as to measure AF volts with or without the DC component. Following microprocessor-operated level control circuits and an output to the AF counter, the signal is fed through a switch-selected 0.3 to 3.4 kHz band-pass filter or 300 Hz or 50 kHz low-pass filter. Output from an RMS detector is analogue-to-digital converted and the AF voltage is displayed.

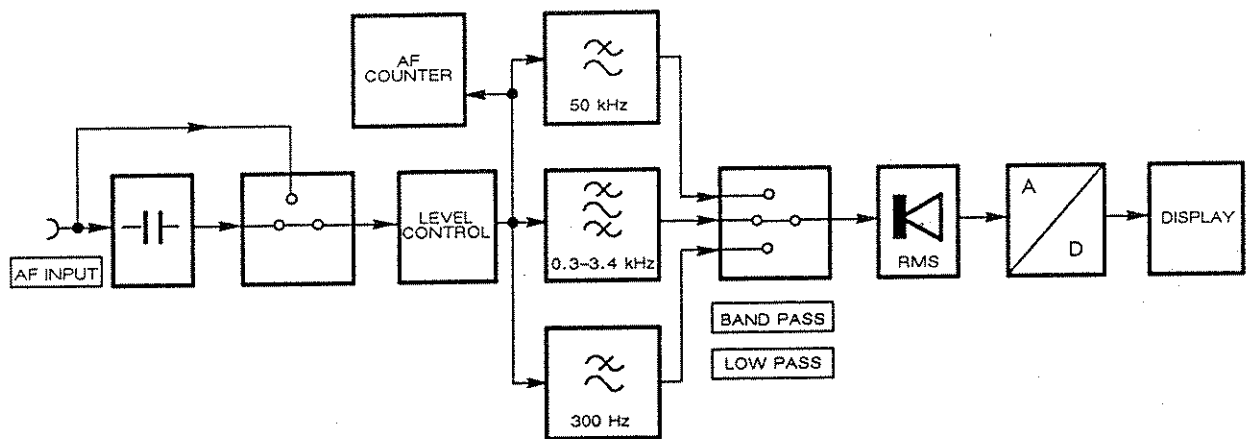

Fig. 5-2 AF voltmeter block diagram

AF GENERATORS

A simplified block diagram is shown in Fig. 5-3.

When they are enabled by means of the AF GEN key and the 1 and 2 keys as appropriate, the AF generators produce one or two frequencies in the range 10 Hz to 20 kHz and also a square wave which is used for digital signalling.

The output frequencies can be set in steps of 0.01 Hz. The output level can be set up to an EMF of 4 V at the AF GEN OUTPUT socket. The AF generators also provide the signal which is used to amplitude modulate, frequency modulate or phase modulate the RF signal generator.

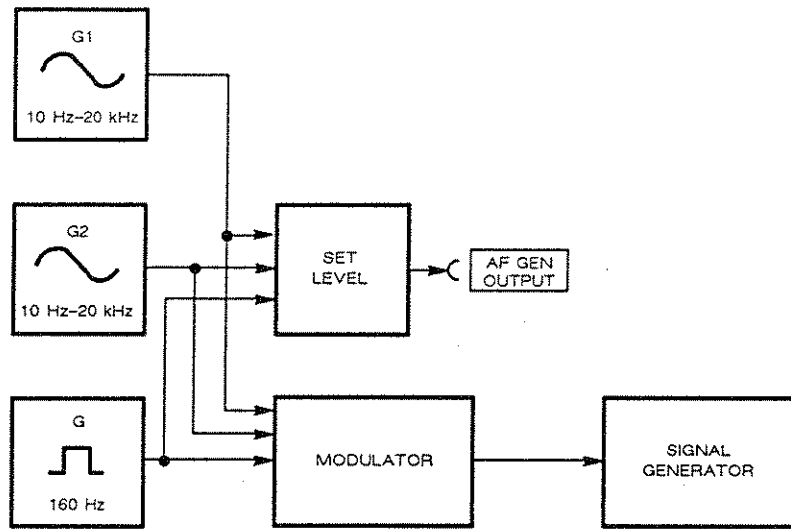

Fig. 5-3 AF generator block diagram

MODULATION METER

A simplified block diagram is shown in Fig. 5-5.

The RF signal can be applied to the RF IN/OUT N or BNC socket. It then follows the same route as in the RF power meter until after the sampling gate. When AM demodulation is selected, the IF is first divided down and then detected. When FM or Φ M demodulation is selected, the signal is frequency to voltage converted which results in a voltage varying at the modulating frequency. For Φ M, the signal additionally passes through a de-emphasis stage. The signal can then be fed through the 0.3 to 3.4 kHz band-pass filter or a 300 Hz or 15 kHz low-pass filter.

At this point, outputs are taken to the AF counter, to the rear panel DE-MOD OUT socket and to an internal loudspeaker which is used for audio monitoring. In the main signal path, microprocessor-operated peak detectors measure the modulation peaks and troughs. The output is analogue-to-digital converted and the modulation level is displayed.

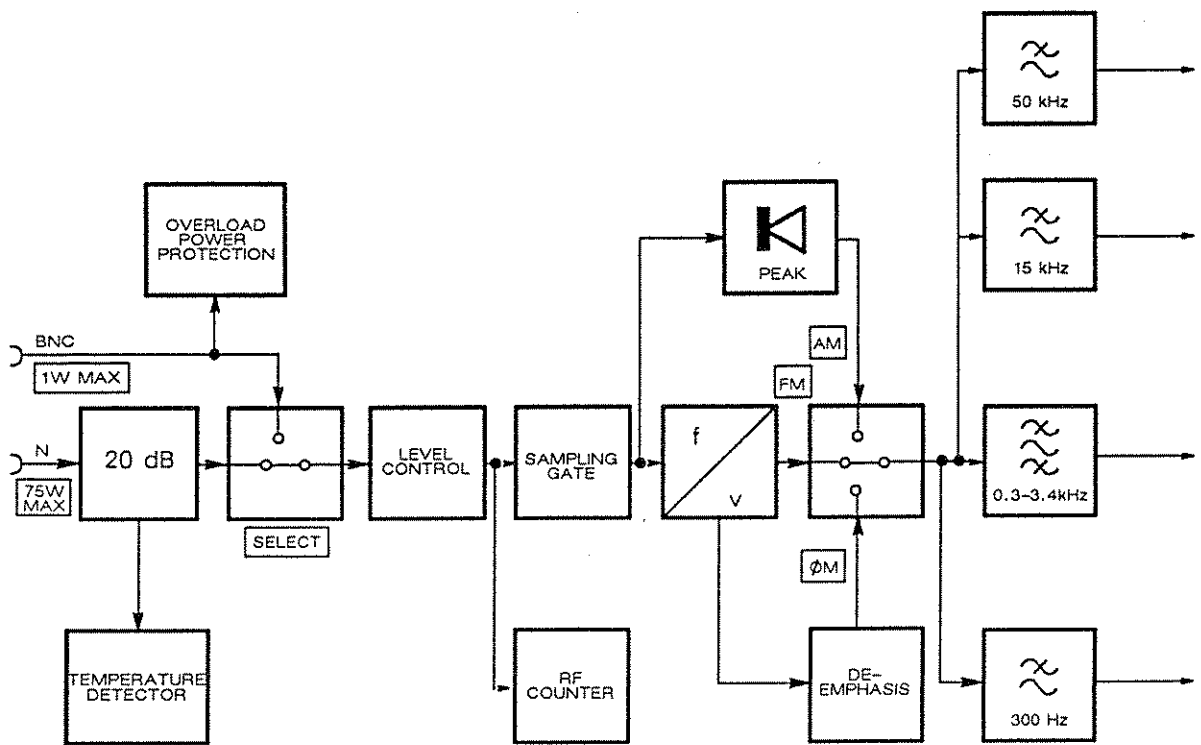

Fig. 5-5 Modulation meter block diagram

RF POWER METER

A simplified block diagram is shown in Fig. 5-4.

Continuous RF power of up to 75 W (or 150 W for a short period) can be applied to the RF IN/OUT N socket which is followed by a 20 dB attenuator and the SELECT switch for the N or BNC socket. Any overload is detected by a heat sensor and results in both visual and audible warnings.

Following microprocessor-operated level control circuits, there are the RF counter and a sampling gate. This gate is switched at a sub-harmonic of the input frequency to produce an IF of 110 kHz. Output from an RMS detector is analogue-to-digital converted and the RF power level is displayed.

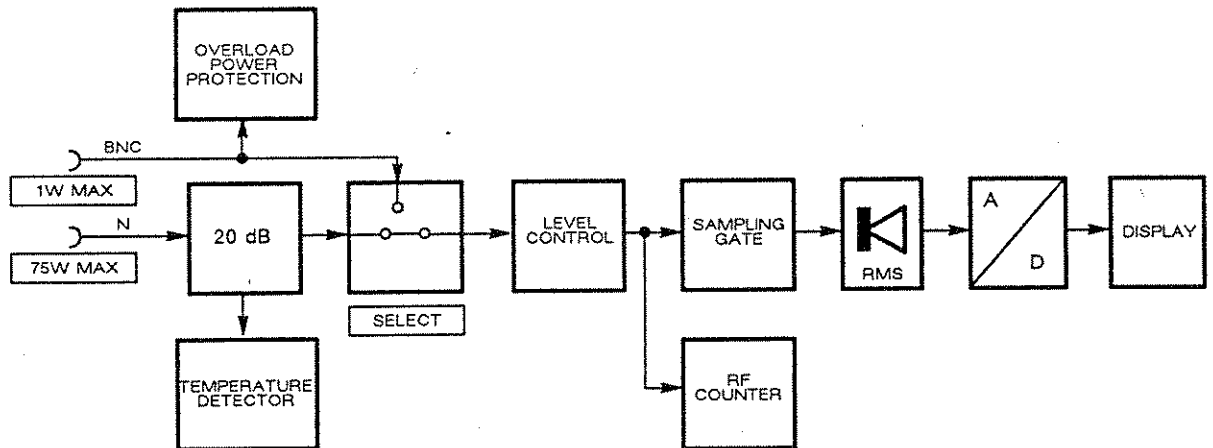
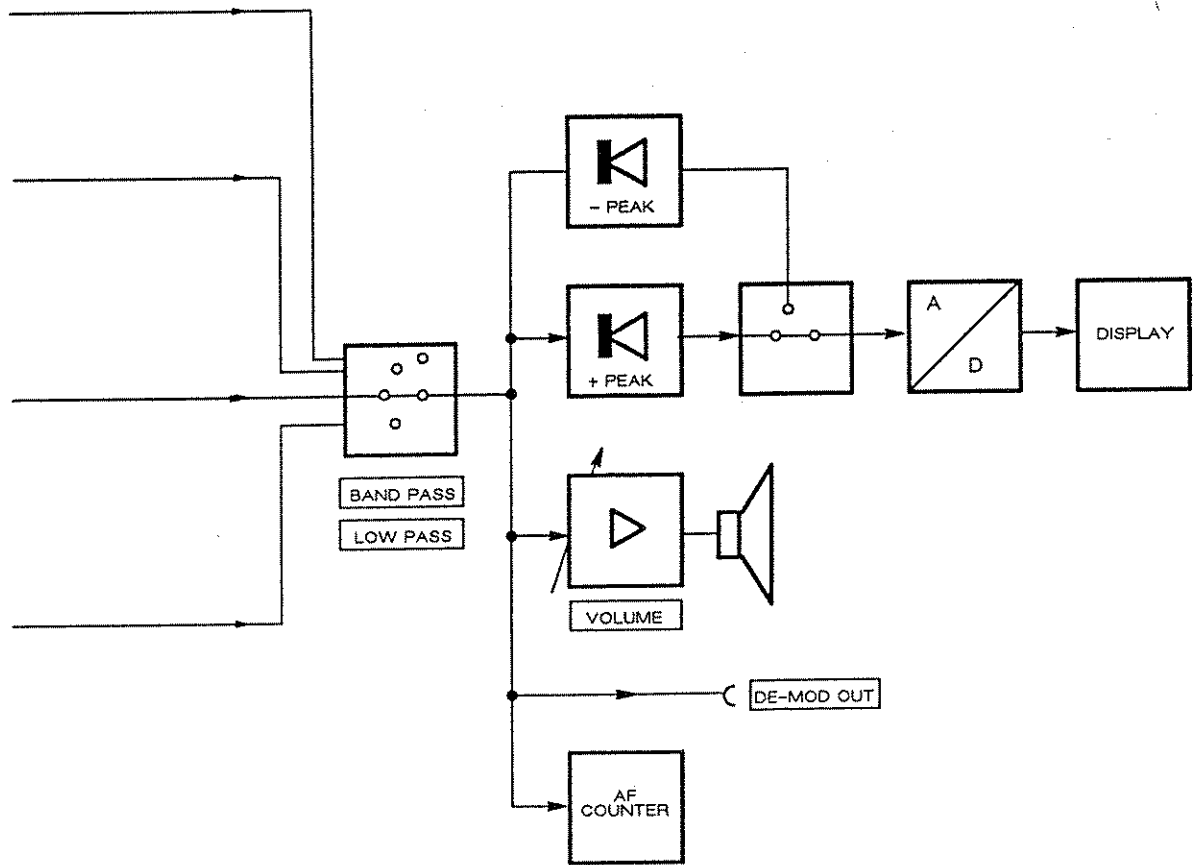

Fig. 5-4 RF power meter block diagram



DISTORTION AND NOISE METER

A simplified block diagram is shown in Fig. 5-6.

For a transmitter measurement, the RF signal can be applied to the RF IN/OUT N or BNC socket. It then follows the same route as in the modulation meter until before the filters.

For a receiver measurement, the receiver's audio output is a frequency of 1 kHz. This is fed through the AF INPUT socket and the coupling capacitor to microprocessor-operated level control circuits.

One of the above signals is then fed through the 0.3 to 3.4 kHz band-pass filter or a low-pass filter of 300 Hz or 15 kHz for a transmitter test or of 300 Hz or 50 kHz for a receiver test. These are followed by a switched 1 kHz band-stop filter which, when it is switched in, removes the fundamental frequency to leave the harmonic distortion. Output from an RMS detector is analogue-to-digital converted and the distortion factor, S/N or SINAD is calculated and displayed.

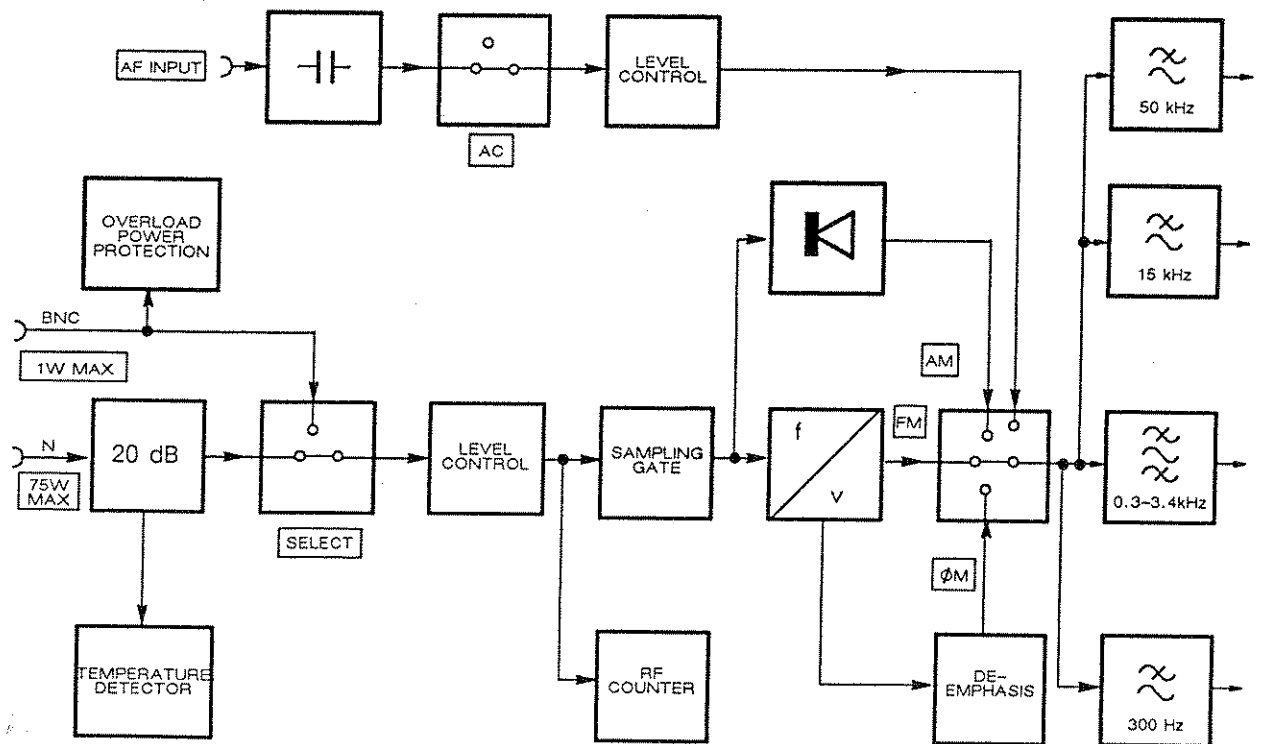

Fig. 5-6 Distortion and noise meter block diagram

The measurements of AF harmonic distortion (D) and noise (N) relative to the signal (S) are as follows:-

$$\text{Distortion factor} = 100 \left\{ \frac{N + D}{S + N + D} \right\} \%$$

$$S/N = 20 \log \left\{ \frac{S + N + D}{N} \right\} \text{ dB}$$

$$\text{SINAD} = 20 \log \left\{ \frac{S + N + D}{N + D} \right\} \text{ dB}$$

Noise is measured in a bandwidth which is automatically selected (0.3 to 3.4 kHz) or manually selected (low pass or external). Noise includes all components apart from the signal and harmonic distortion.

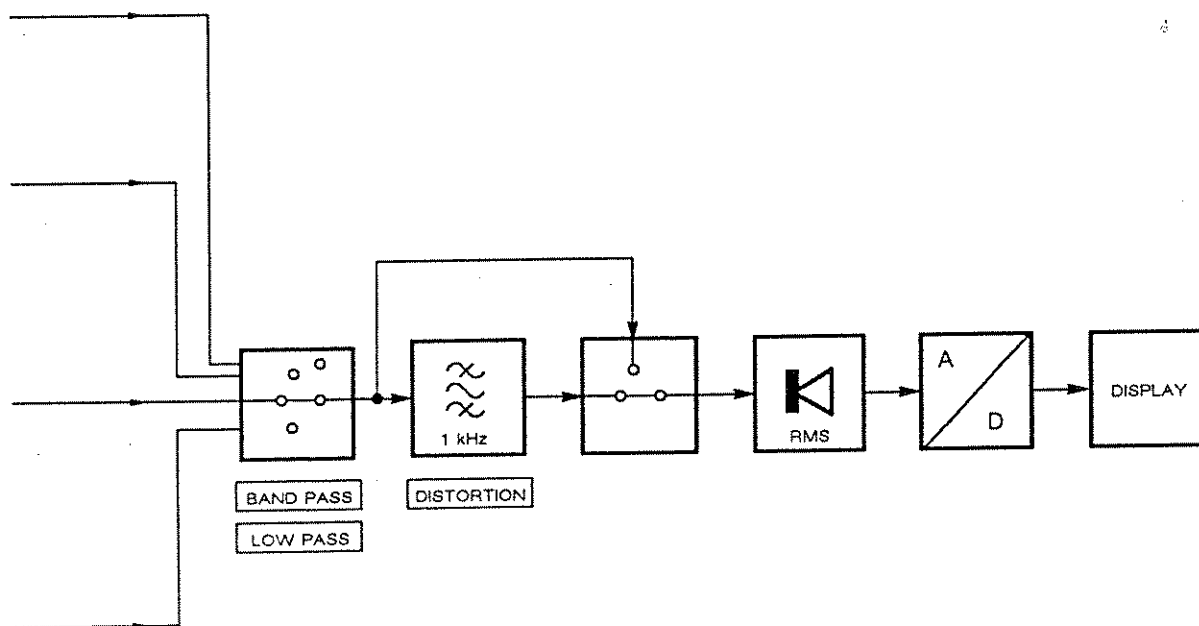

SENSITIVE RECEIVER (Option 1 only)

The receiver circuits are carried on two PCBs which are housed in a separate tray.

In the Option 1, there is a bypass switch assembly which connects the RF IN/OUT connectors to the sensitive receiver.

The RF signal generator is used as the local oscillator. There is an attenuator and switch assembly which connects the RF signal generator to the sensitive receiver.

The incoming signal is converted to an IF of 21.4 MHz. When the local oscillator frequency is set above 21.4 MHz, reception can be obtained at two frequencies. The local oscillator can be set so that the RF IMAGE is UPPER or LOWER.

The receiver IF output is levelled by the use of an AGC loop which provides the displayed level measurement. 0/10 dB and 0/32 dB amplifiers are automatically switched to set the gain. An internal calibration routine improves the accuracy.

There is an IF filter which provides two bandwidths for setting selectivity and sensitivity.

Chapter 6

ACCEPTANCE TESTING

	Page
TESTING	6-2
OSCILLOSCOPE	6-2
DC offset	6-2
AF level	6-2
Demodulated FM	6-3
Demodulated AM	6-5
MODULATION METER	6-6
Demodulation distortion	6-6
AM depth	6-7
FM deviation	6-9
Input sensitivity	6-10
VOLTMETER	6-11
Level accuracy at DC and 1 kHz	6-11
Frequency response	6-12
RF FREQUENCY METER	6-13
Frequency	6-13
Input sensitivity	6-14
AF FREQUENCY METER	6-15
Frequency and sensitivity	6-15
AF GENERATORS	6-16
Output level (EMF)	6-16
Distortion	6-17
Frequency	6-18
DC offset	6-19
Residual noise	6-19
Waveform shapes	6-20
DTMF ENCODER AND DECODER	6-21
DISTORTION AND NOISE METER	6-22
Distortion	6-22
RF POWER METER	6-23
Level and frequency response	6-23
SEQUENTIAL TONES	6-25
Operation	6-25
RF GENERATOR	6-26
Output level	6-26
Frequency	6-27
AM depth	6-28
FM deviation	6-29
AM and FM distortion	6-30
External AM and FM... ..	6-31
RF leakage	6-32
FM on CW	6-33
Harmonics... ..	6-34
Sub-harmonics	6-34
Spurious signals... ..	6-35
SENSITIVE OFF-AIR RECEIVER (Option 1 only)... ..	6-36
Sensitivity	6-36
Level... ..	6-37

TESTING

Test procedures in this chapter may be simplified and of restricted range compared with the comprehensive factory test facilities which are necessary to demonstrate complete compliance with the specifications.

Performance limits quoted are for guidance and should not be taken as guaranteed performance specifications unless they are also quoted under 'Performance data' in Chap. 1.

When verifying that the instrument meets the stated performance limits, always make allowance for the uncertainty of the test equipment which is used.

OSCILLOSCOPE

DC offset

Proceed as follows:-

- (1) Short circuit the AF INPUT socket.
- (2) Set the MODE to RECEIVER TEST, SCOPE/BAR to SCOPE and AC DC to DC.
- (3) Use the vertical POSITION control to bring the trace onto the centre of the graticule.
- (4) Scan through the VERT scale ranges and check that the trace does not move more than 1/4 division between ranges.

AF level

This section is used to check compliance with the following:-

Frequency range and accuracy: DC (3 Hz on AC) to 50 kHz $\pm 5\%$.

The following test equipment is required:-

Description	Minimum specification	Example
AC/DC calibrator	Accuracy 1.5% DC.	Rotek 3950

Proceed as follows:-

- (1) Connect the AC/DC calibrator to the AF INPUT socket. See Fig. 6-1.
- (2) On the 2955B, set the MODE to RECEIVER TEST, SCOPE/BAR to SCOPE, AC DC to DC, FILTER to 50 kHz LOW PASS and DIST'N, S/N and SINAD to off.
- (3) On the 2955B, use the vertical POSITION control to move the trace to the bottom dotted graticule line.
- (4) On the 2955B, set the VERT scale range to 2 V/div.

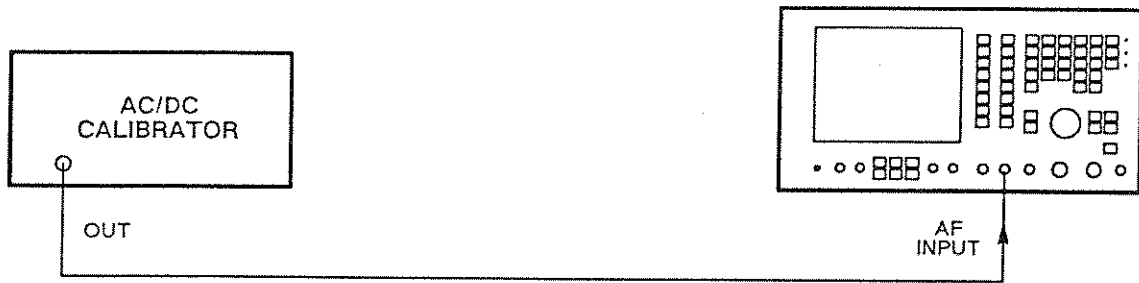

Fig. 6-1 Test equipment connections for oscilloscope AF level

- (5) Set the calibrator to output + DC and adjust the level until the oscilloscope trace appears on the top dotted graticule line. On the calibrator, check that the output is 9.5 to 10.5 V.
- (6) Repeat (4) and (5) for the other VERT scale ranges and calibrator limits as follows:-

Scale range	Nominal DC	Calibrator limits
2 V/div	10 V	9.5 to 10.5 V
1 V/div	5 V	4.75 to 5.25 V
500 mV/div	2.5 V	2.375 to 2.625 V
50 mV/div	0.25 V	0.2375 to 0.2625 V

Demodulated FM

This section is used to check compliance with the following:-

FM deviation accuracy: $\pm 10\%$.

The following test equipment is required:-

Description	Minimum specification	Example
FM signal generator	100 MHz, level 7 dBm.	MI 2019A
FM modulation meter	100 MHz, accuracy >3%.	MI 2305
Power splitter	6 dB, 50 Ω , 100 MHz.	HP 11667A

Proceed as follows :-

- (1) Connect the signal generator to the input of the power splitter. Connect the outputs of the power splitter to the RF IN/OUT BNC socket and to the modulation meter. See Fig. 6-2.
- (2) On the 2955B, set the MODE to TRANSMITTER TEST, MOD to FM, SCOPE/BAR to SCOPE, FILTER to 0.3-3.4 kHz BAND PASS and RF IN/OUT socket to BNC.

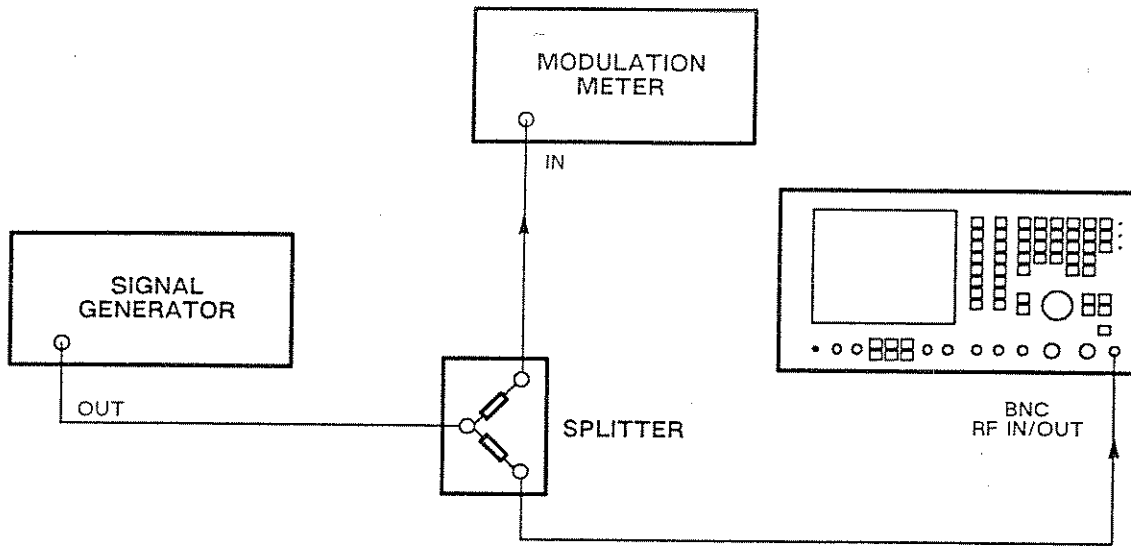

Fig. 6-2 Test equipment connections for oscilloscope demodulated FM and demodulated AM

- (3) Set the signal generator carrier frequency to 100 MHz, level to 7 dBm, FM and 1 kHz internal modulating frequency.
- (4) Set the modulation meter to FM, p-p/2, in a 0.3 to 3.4 kHz bandwidth.
- (5) On the 2955B, set the VERT scale range to >30 kHz deviation.
- (6) Adjust the signal generator FM deviation until the FM deviation is shown on the oscilloscope as 20 kHz.
- (7) On the modulation meter, check that the reading is 18.0 to 22.0 kHz.
- (8) Repeat (5) to (7) for the other oscilloscope ranges and deviation limits as follows:-

Scale range	Deviation on oscilloscope	Modulation meter reading
30 kHz	20 kHz	18.0 to 22.0 kHz
15 kHz	10 kHz	9.0 to 11.0 kHz
6 kHz	4 kHz	3.6 to 4.4 kHz
3 kHz	2 kHz	1.8 to 2.2 kHz
1.5 kHz	1 kHz	0.9 to 1.1 kHz

Demodulated AM

This section is used to check compliance with the following:--

AM depth accuracy: $\pm 10\%$.

The following test equipment is required:--

Description	Minimum specification	Example
AM signal generator	100 MHz, level 7 dBm.	MI 2019A
AM modulation meter	100 MHz, accuracy >3%.	MI 2305
Power splitter	6 dB, 50 Ω , 100 MHz.	HP 11667A

Proceed as follows:--

- (1) Connect the signal generator to the input of the power splitter. Connect the outputs of the power splitter to the RF IN/OUT BNC socket and to the modulation meter. See Fig. 6-2.
- (2) On the 2955B, set the MODE to TRANSMITTER TEST, MOD to AM, SCOPE/BAR to SCOPE, FILTER to 0.3-3.4 kHz BAND PASS and RF IN/OUT socket to BNC.
- (3) Set the signal generator carrier frequency to 100 MHz, level to 7 dBm, AM and 1 kHz internal modulating frequency.
- (4) Set the modulation meter to AM, p-p/2, in a 0.3 to 3.4 kHz bandwidth.
- (5) On the 2955B, set the VERT scale range to 20%/div.
- (6) Adjust the signal generator depth until the waveform is shown on the oscilloscope as 80%.
- (7) On the modulation meter, check that the reading is 72 to 88%.
- (8) Repeat (5) to (7) for the other VERT scale ranges and modulation depths as follows:--

Scale range	AM depth on oscilloscope	Modulation meter reading
20	80%	72 to 88%
10	40%	36 to 44%
5	20%	18 to 22%

- (6) On the 2955B, reset MOD to FM.
- (7) Reset the signal generator modulation level to 5 kHz FM, modulating frequency to 1 kHz and carrier frequency to 100 MHz.
- (8) Tune the distortion meter and check that the reading is <1.5%.

AM depth

This section is used to check compliance with the following:-

Accuracy: $\pm 5\%$ of reading ± 1 digit at 1 kHz,
 $\pm 8.5\%$ of reading ± 1 digit at 50 Hz to 10 kHz.

The following test equipment is required:-

Description	Minimum specification	Example
AM signal generator	1.4 to 400 MHz, external modulation 50 Hz to 10 kHz, 0 to 90%, RF level 13 dBm.	MI 2019A
AM modulation meter	1.5 to 400 MHz, accuracy 1%.	MI 2305
LF synthesizer	50 Hz to 10 kHz, 1 V RMS level.	HP 3325A or B
Power splitter	6 dB, 50 Ω , 1.5 to 400 MHz.	HP 11667A

Proceed as follows:-

- (1) Connect the signal generator to the input of the power splitter. Connect the outputs of the power splitter to the RF IN/OUT BNC socket and to the modulation meter. See Fig. 6-4.
- (2) On the 2955B, set the MODE to TRANSMITTER TEST, MOD to AM, FILTER to 0.3-3.4 kHz BAND PASS and RF IN/OUT socket to BNC.

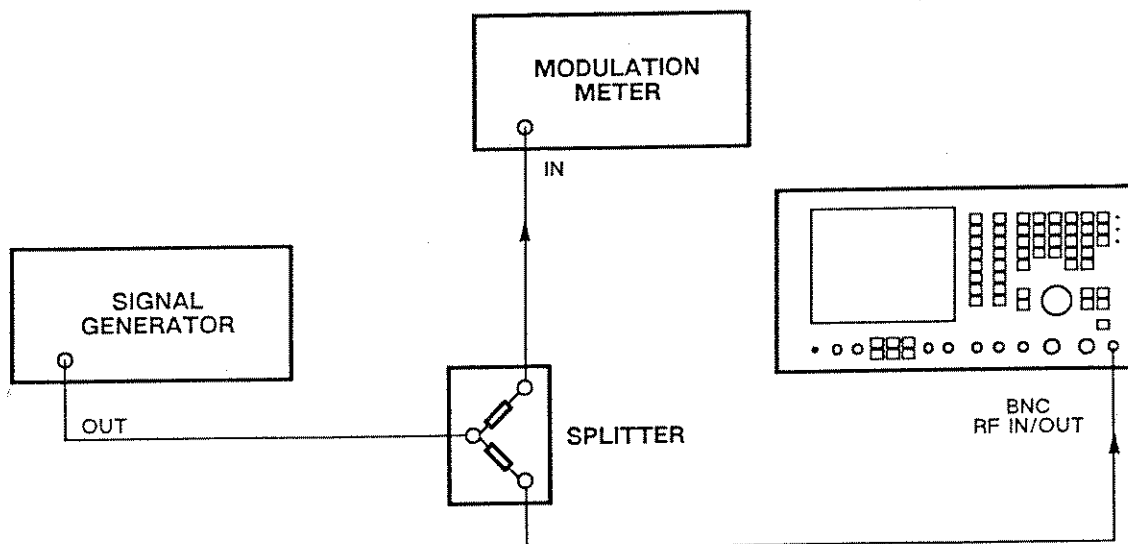

Fig. 6-4 Test equipment connections for modulation meter AM depth and FM deviation

- (3) Set the signal generator carrier frequency to 100 MHz, level to 7 dBm, 80% AM and 1 kHz internal modulating frequency.
- (4) Set the modulation meter to AM in a 0.3 to 3.4 kHz bandwidth.
- (5) Check that the MOD LEVEL is the same as the modulation meter reading $\pm 5\% \pm 1$ digit. Check that the AM bar chart indicates the AM being applied.
- (6) Repeat (3) and (5) for other modulation depths from 0 to 90% and other carrier frequencies between 1.5 and 100 MHz.
- (7) Repeat (3) and (5) for other modulation depths from 0 to 80% and other carrier frequencies between 1.5 and 400 MHz.
- (8) Connect the LF generator to the signal generator modulation input. See Fig. 6-5.
- (9) On the 2955B, set the FILTER to 15 kHz LOW PASS.
- (10) Set the signal generator carrier frequency to 100 MHz, level to 7 dBm and 80% external AM at a 10 kHz modulating frequency (from the LF generator).
- (11) Set the modulation meter to AM in a 30 Hz to 50 kHz bandwidth.
- (12) Set the synthesized LF generator to give a 10 kHz sinewave. Adjust the level to suit the external modulation input of the signal generator.
- (13) Check that the MOD LEVEL is the same as the modulation meter reading $\pm 8.5\% \pm 1$ digit.
- (14) Repeat (12) and (13) for other modulating frequencies between 50 Hz and 10 kHz.

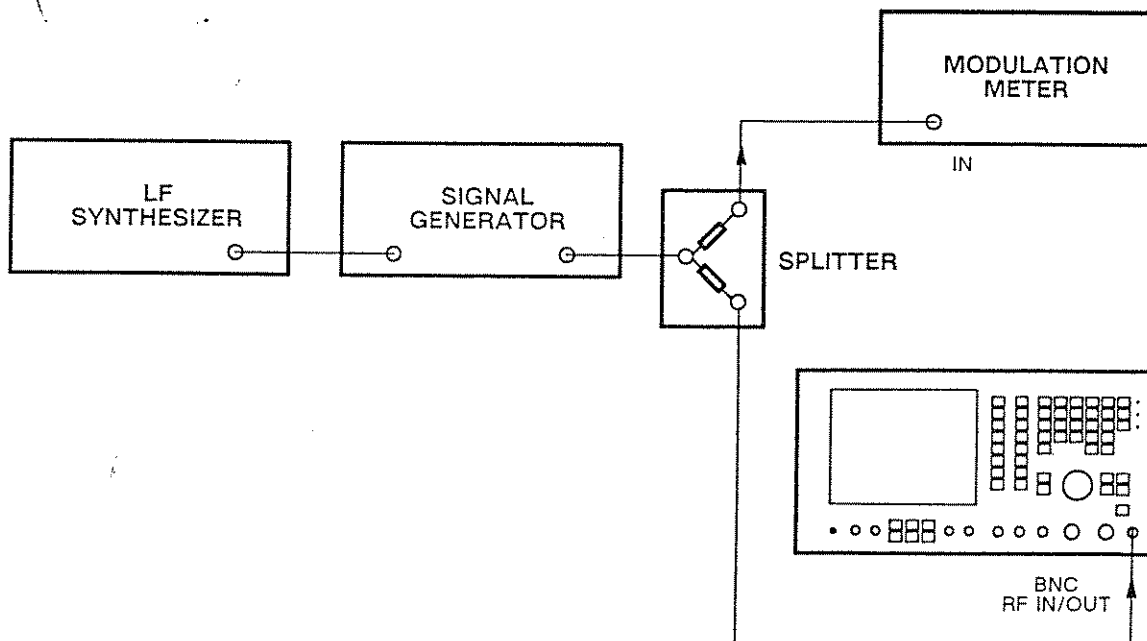

Fig. 6-5 Test equipment connections for modulation meter AM depth and FM deviation

FM deviation

This section is used to check compliance with the following:-

Accuracy: $\pm 5\% \pm 1$ digit at 1 kHz,
 $\pm 7.5\% \pm 1$ digit at 50 Hz to 10 kHz.

The following test equipment is required:-

Description	Minimum specification	Example
FM signal generator	1.5 to 1000 MHz, level 13 dBm, deviation 0 to 25 kHz, external modulation 50 Hz to 10 kHz.	MI 2019A
FM modulation meter	1.5 to 1000 MHz, accuracy 1%.	MI 2305
LF synthesizer	50 Hz to 10 kHz, 1 V RMS level.	HP 3325A or B
Power splitter	6 dB, 50 Ω , 1.5 to 1000 MHz.	HP 11667A

Proceed as follows:-

- (1) Connect the signal generator to the input of the power splitter. Connect the outputs of the power splitter to the RF IN/OUT BNC socket and to the modulation meter. See Fig. 6-4.
- (2) On the 2955B, set the MODE to TRANSMITTER TEST, MOD to FM, FILTER to 0.3-3.4 kHz BAND PASS, DIST'N, S/N and SINAD to off and RF IN/OUT socket to BNC.
- (3) Set the signal generator carrier frequency to 500 MHz, level to 13 dBm, 25 kHz FM and 1 kHz internal modulating frequency.
- (4) Set the modulation meter to FM in a 0.3 to 3.4 kHz bandwidth.
- (5) Check that the MOD LEVEL reading is the same as the modulation meter reading $\pm 5\% \pm 1$ digit. Check that the FM bar chart indicates the FM being applied.
- (6) Repeat (3) and (5) for other carrier frequencies from 1.5 to 1000 MHz and deviations between 0 and 25 kHz.
- (7) On the 2955B, set the FILTER to 15 kHz LOW PASS.
- (8) Set the signal generator carrier frequency to 500 MHz, level to 13 dBm, modulation level to 25 kHz external FM at 10 kHz modulating frequency (from the LF generator).
- (9) Set the modulation meter to FM in a 30 Hz to 50 kHz bandwidth.
- (10) Set the synthesized LF generator to give a 10 kHz sinewave. Adjust the level to suit the external modulation input of the signal generator.
- (11) Check that the MOD LEVEL reading is the same as the modulation meter reading $\pm 7.5\%$.

Input sensitivity

This section is used to check compliance with the following:-

Sensitivity: N socket; 5 mW in transmitter test mode,
20 mW in one-port duplex mode.

The following test equipment is required:-

Description	Minimum specification	Example
FM signal generator	1.5 to 1000 MHz, 1 MHz standard output, level 13 dBm.	MI 2019A
Power meter and sensor	1.5 to 1000 MHz, -30 to +20 dBm.	MI 6960A and 6912

Proceed as follows:-

- (1) Connect the signal generator 1 MHz standard output to the EXT STD 1 MHz socket. Connect the power meter through its sensor to the signal generator variable output. See Fig. 6-6.
- (2) On the 2955B, set the mode to TRANSMITTER TEST, MOD to FM, FILTER to 0.3-3.4 kHz BAND PASS and RF IN/OUT to N.
- (3) Set the signal generator carrier frequency to 400 MHz, modulation level to 10 kHz FM and modulating frequency to 1 kHz.
- (4) On the signal generator, adjust the RF level to give a reading of 5 mW on the power meter.
- (5) Transfer the signal generator variable output to the RF IN/OUT N socket.
- (6) On the modulation meter, check that the reading is 10 kHz.
- (7) On the 2955B, set the MODE to DUPLEX test and SELECT to ONE PORT.
- (8) Transfer the signal generator variable output to the power meter.
- (9) Repeat (3) to (6) except that, on the signal generator, adjust the RF level to give a reading of 20 mW on the power meter.

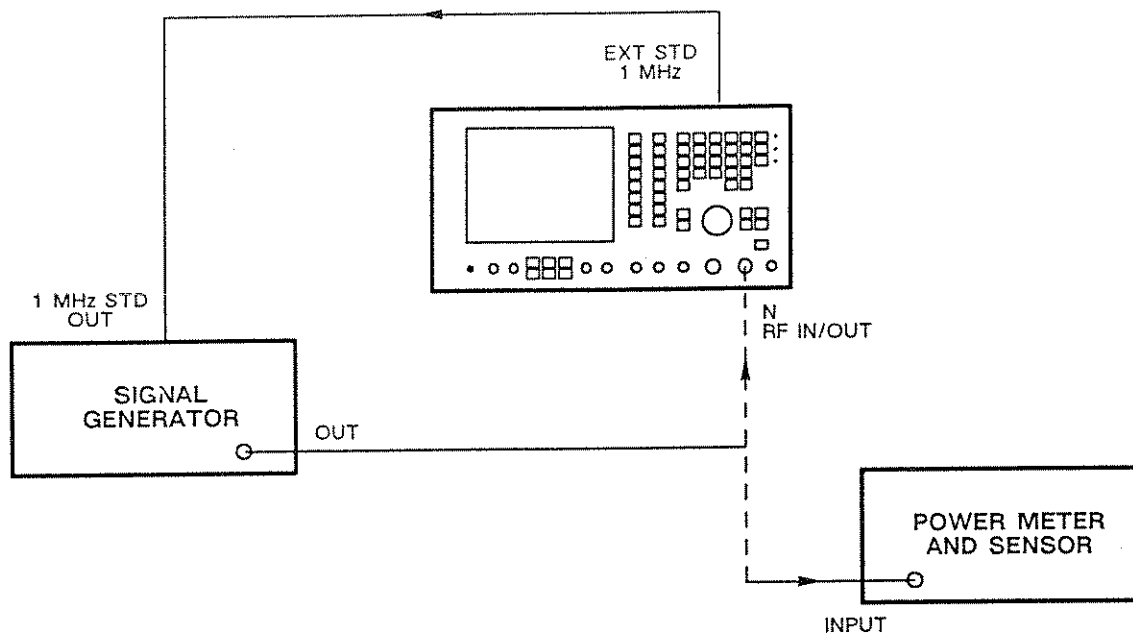

Fig. 6-6 Test equipment connections for modulation meter input sensitivity

VOLTMETER

Level accuracy at DC and 1 kHz

This section is used to check compliance with the following:-

Accuracy: $\pm 3\%$ of reading ± 3 mV ± 1 digit.

The following test equipment is required:-

Description	Minimum specification	Example
AC/DC calibrator	DC 0 to 100 V, AC 1 kHz, level accuracy better than 0.05%.	Rotek 3950

Proceed as follows:-

- (1) Connect the AC/DC calibrator to the AF INPUT socket. See Fig. 6-7.
- (2) On the 2955B, set the MODE to AUDIO TEST, AC DC to DC, FILTER to 50 kHz LOW PASS and DIST'N to off.
- (3) Set the calibrator to give 1.000 V DC.
- (4) Check that the AF voltmeter reading is the same as the calibrator voltage $\pm 3\%$ ± 3 mV ± 1 digit.
- (5) Repeat setting the calibrator to other DC levels up to 100 V and repeat (4).
- (6) Check the operation of the bar chart and oscilloscope.
- (7) On the 2955B, set AC DC to AC.

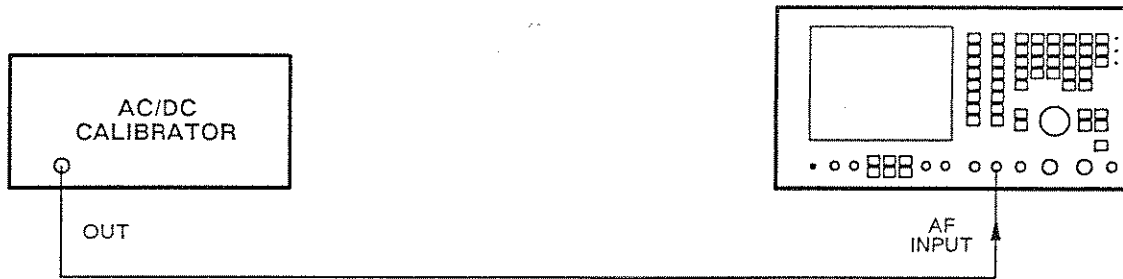

Fig. 6-7 Test equipment connections for voltmeter level at DC and 1 kHz

- (8) Set the calibrator to give 1.000 V AC at 1 kHz.
- (9) Check that the AF voltmeter reading is the same as the calibrator voltage $\pm 3\%$ of ± 3 mV ± 1 digit.
- (10) Repeat (8) and (9) at 1 kHz at other levels up to 100 V.

Frequency response

This section is used to check compliance with the following:-

Accuracy: $\pm 3\%$ of reading ± 3 mV ± 1 digit.

The following test equipment is required:-

Description	Minimum specification	Example
LF synthesizer	50 Hz to 20 kHz, level 2 V RMS.	HP 3325A or B or R&S SPN
RMS DVM	50 Hz to 20 kHz, accuracy better than 0.02%.	Datron 1065A

Proceed as follows:-

- (1) Connect the LF generator and the DVM to the AF INPUT socket. See Fig. 6-8.
- (2) On the 2955B, set the MODE to AUDIO TEST, AC DC to AC, FILTER to 50 kHz LOW PASS and DIST'N to off.
- (3) Set the synthesized LF generator to give a 1 kHz sinewave at 1 V RMS into 50 Ω .
- (4) Set the DVM to AC, RMS.
- (5) Check that the AF voltmeter reading is the same as the DVM reading $\pm 3\%$ ± 3 mV ± 1 digit.
- (6) Repeat (3) and (5) at other frequencies between 50 Hz and 20 kHz.

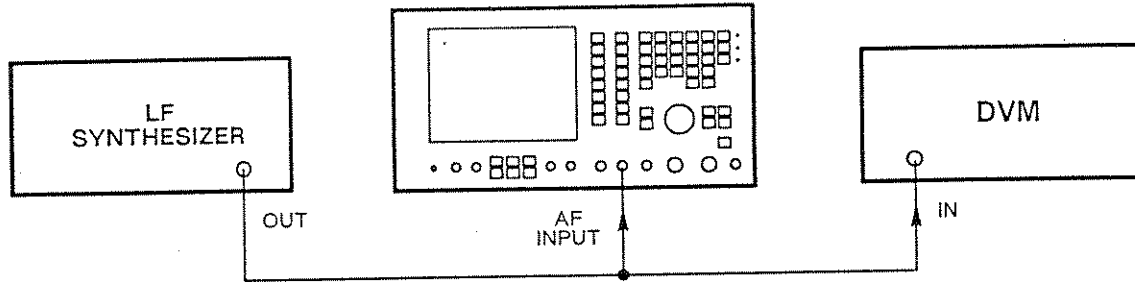

Fig. 6-8 Test equipment connections for voltmeter frequency response

RF FREQUENCY METER

Frequency

This section is used to check compliance with the following:-

Accuracy: As internal standard >1 digit.

The following test equipment is required:-

Description	Minimum specification	Example
Signal generator	1.5 to 1000 MHz, 1 MHz standard output	MI 2019A

The following method is used to check that the RF frequency meter (internal counters/dividers) is working correctly. However, overall accuracy depends upon the correct setting of the internal 10 MHz standard. Proceed as follows:-

- (1) Connect the signal generator 1 MHz standard output to the EXT STD 1 MHz socket. Connect the signal generator variable output to the RF IN/OUT BNC socket. See Fig. 6-9.
- (2) On the 2955B, set the MODE to TRANSMITTER TEST and RF IN/OUT socket to BNC.
- (3) Set the signal generator carrier frequency to 1000 MHz, level to 7 dBm and modulation to off.
- (4) Check that the TX FREQ reading is the same as the signal generator setting ± 1 digit.
- (5) Repeat (3) and (4) at other frequencies between 1.5 and 1000 MHz.

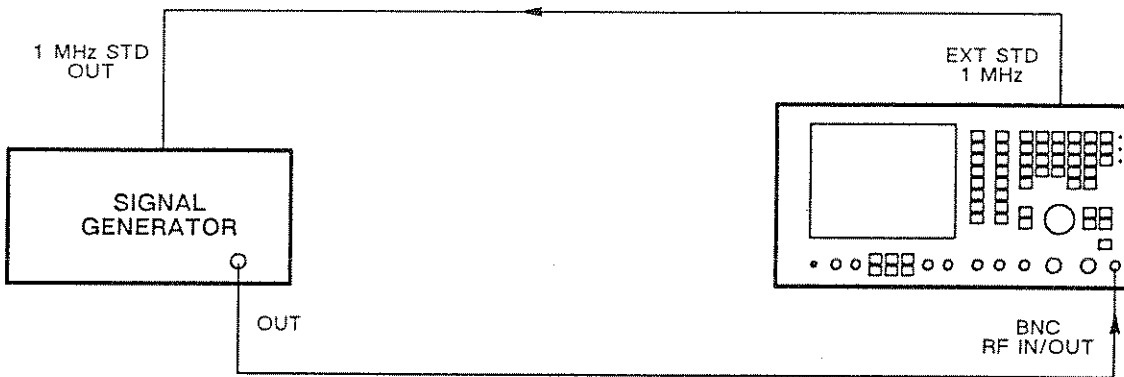

Fig. 6-9 Test equipment connections for RF frequency meter frequency

Input sensitivity

This section is used to check compliance with the following:-

Sensitivity: N socket; 5 mW in transmitter test mode,
20 mW in one-port duplex mode.

The following test equipment is required:-

Description	Minimum specification	Example
FM signal generator	1.5 to 1000 MHz, 1 MHz standard output, level 13 dBm.	MI 2019A
Power meter and sensor	1.5 to 1000 MHz, -30 to +20 dBm.	MI 6960A and 6912

Proceed as follows:-

- (1) Connect the signal generator 1 MHz standard output to the EXT STD 1 MHz socket. Connect the power meter through its sensor to the signal generator variable output. See Fig. 6-10.
- (2) On the 2955B, set TRANSMITTER TEST mode and the RF IN/OUT socket to N.
- (3) Set the signal generator carrier frequency to 100 MHz and modulation to off.
- (4) On the signal generator, adjust the RF level to give a reading of 5 mW on the power meter.
- (5) Transfer the signal generator variable output to the RF IN/OUT N socket.
- (6) Check that the RF frequency meter is locked and stable and that the reading is the same as the signal generator setting ± 10 Hz.
- (7) Transfer the signal generator variable output to the power meter.
- (8) Repeat (3) to (6) for other frequencies from 1.5 to 1000 MHz.

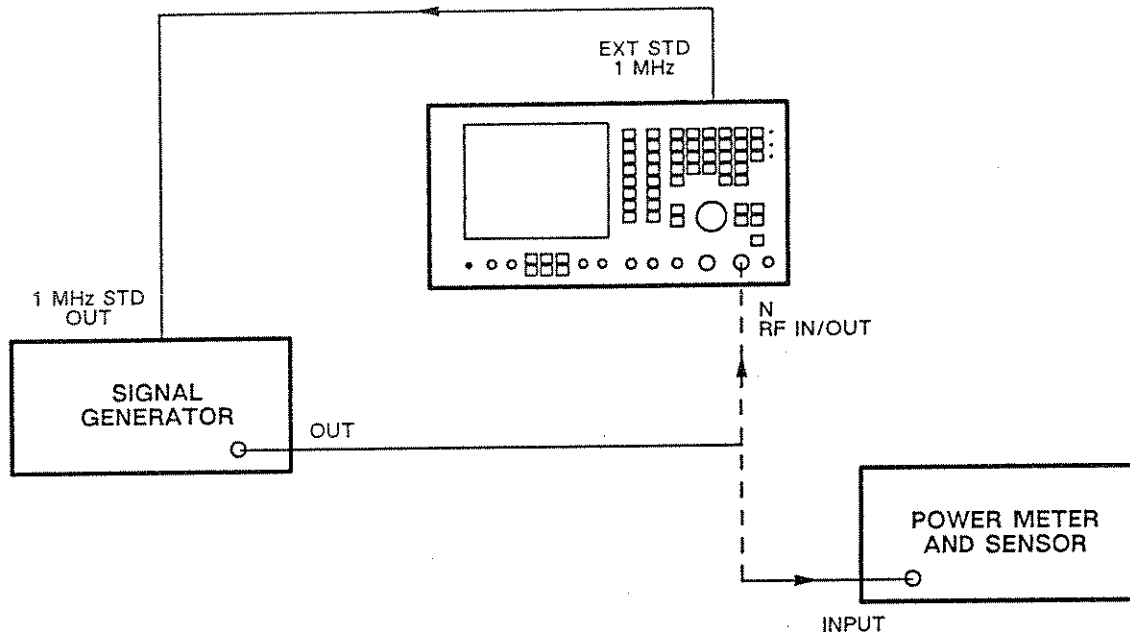

Fig. 6-10 Test equipment connections for RF frequency meter input sensitivity

AF FREQUENCY METER

Frequency and sensitivity

This section is used to check compliance with the following:-

Range:	20 Hz to 20 kHz.
Accuracy:	As internal standard ± 1 digit, ± 0.1 Hz or 0.02% (whichever is greater).
Sensitivity:	50 mV.

The following test equipment is required:-

Description	Minimum specification	Example
LF synthesizer	20 Hz to 20 kHz, 1 MHz standard output.	HP 3325A or B
DVM	0.5% accuracy.	Datron 1065A

The following method is used to check that the AF frequency meter is working correctly. However, overall accuracy depends upon the correct setting of the internal 10 MHz standard. Proceed as follows:-

- (1) Connect the LF synthesizer 1 MHz standard output to the EXT STD 1 MHz socket. Connect the LF synthesizer variable output to the AF INPUT socket. See Fig. 6-11.
- (2) On the 2955B, set the MODE to AUDIO TEST, AC DC to AC, FILTER to 50 kHz LOW PASS and DIST'N to off.

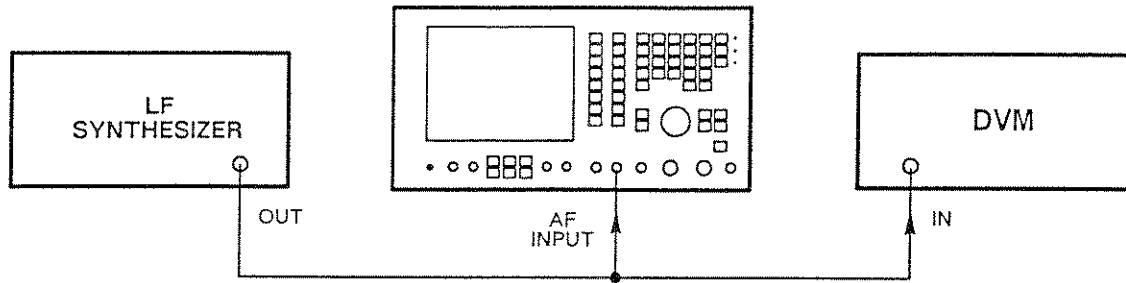

Fig. 6-11 Test equipment connections for AF frequency meter frequency and sensitivity

- (3) Set the synthesized LF generator to give a 20 kHz sinewave.
- (4) Set the DVM to read AC and RMS.
- (5) Adjust the LF synthesizer output level until the reading on the DVM is 50 mV.
- (6) Check that the AF FREQ reading is the same as the synthesizer setting ± 1 digit ± 0.1 Hz/0.02%.
- (7) Repeat (3) and (6) at other frequencies between 20 Hz and 20 kHz.

AF GENERATORS

Output level (EMF)

This section is used to check compliance with the following:-

Range: 0.1 mV to 4.095 V RMS (sine and square),
0.1 mV to 4.095 V peak (triangle).

Accuracy: $\pm 5\% \pm 1$ step, 50 Hz to 15 kHz.

Check each of the two AF generators by following the procedures as given below for GEN1. For GEN2, set GEN1 to OFF and set GEN2 to ON. Press the TONES and AUDIO SETUP keys to confirm or reset these on the menu.

The following test equipment is required:-

Description	Minimum specification	Example
RMS voltmeter	50 mV to 4.095 V RMS, 50 Hz to 15 kHz, accuracy better than 0.5%.	Datron 1065A

Proceed as follows:-

- (1) Connect the DVM to the AF GEN OUTPUT socket. See Fig. 6-12.
- (2) On the 2955B, set the MODE to AUDIO TEST. Ensure that GEN 1 is ON and GEN 2 is OFF. Press the TONES and AUDIO SETUP keys. Set the GEN 1 FREQ to 1 kHz, LEVEL to 1 V and SHAPE to SINE.
- (3) Check that the voltmeter reading is the same as the GEN FREQ setting $\pm 5\% \pm 1$ step.

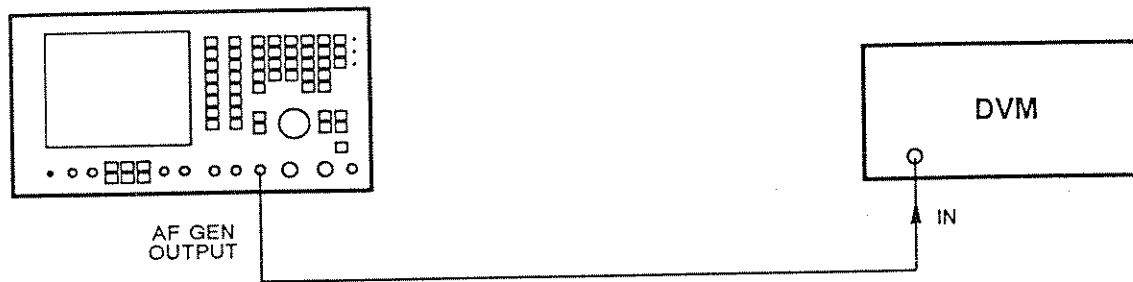

Fig. 6-12 Test equipment connections for AF generator output level accuracy

- (4) Reset the GEN 1 FREQ to other frequencies and LEVEL to other levels and repeat (3). When checking very low levels, the limitations of the DVM should be taken into account.

Distortion

This section is used to check compliance with the following:-

Distortion: <math><0.3\%</math> at 1 kHz. <math><0.6\%</math> from 50 Hz to 15 kHz (excluding residual noise).

The following test equipment is required:-

Description	Minimum specification	Example
Distortion meter	50 Hz to 15 kHz, better than 0.2% distortion.	MI TF 2331A

Proceed as follows:-

- (1) Connect the distortion meter to the AF GEN OUTPUT socket. See Fig. 6-13.
- (2) On the 2955B, set the MODE to AUDIO TEST. Ensure that GEN 1 is ON and GEN 2 is OFF. Press the TONES and AUDIO SETUP keys. Set the GEN 1 FREQ to 5 kHz, LEVEL to 2 V and SHAPE to SINE.
- (3) Tune the distortion meter and check that the reading is <math><0.6\%</math>.
- (4) Reset the GEN 1 FREQ to other frequencies and LEVEL to other deviations between 50 Hz and 15 kHz.
- (5) On the 2955B, reset the AF GEN FREQ to 1 kHz.
- (6) Tune the distortion meter and check that the reading is <math><0.3\%</math>.

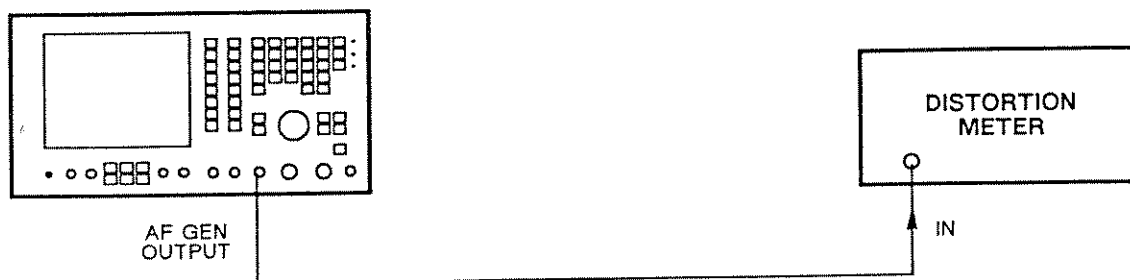

Fig. 6-13 Test equipment connections for AF generator distortion

Frequency

This section is used to check compliance with the following:-

Accuracy: ± 0.01 Hz from 10 Hz to 100 Hz,
 ± 0.1 Hz from 100 Hz to 20 kHz.

The following test equipment is required:-

Description	Minimum specification	Example
AF counter/timer	50 Hz to 15 kHz, accuracy better than 0.1 Hz.	MI 2438.

Proceed as follows:-

- (1) Connect the counter/timer to the AF GEN OUTPUT socket. See Fig. 6-14.
- (2) On the 2955B, set the MODE to AUDIO TEST. Ensure that GEN 1 is ON and GEN 2 is OFF. Press the TONES and AUDIO SETUP keys. Set the GEN 1 FREQ to 15 kHz, LEVEL to 1 V and SHAPE to SINE.
- (3) Set the counter/timer to read period (to gain the required resolution).
- (4) On the counter/timer, check that the reading is between 66666.2 and 66667.1 ns (15 kHz ± 0.1 Hz).
- (5) Reset the GEN 1 FREQ to other frequencies between 100 Hz and 20 kHz and repeat (4) except check that the counter/timer readings are the same as the GEN FREQ setting ± 0.1 Hz.
- (6) Reset the GEN 1 FREQ to other frequencies between 10 Hz and 100 Hz and repeat (4) except check that the counter/timer readings are the same as the GEN FREQ settings ± 0.01 Hz.

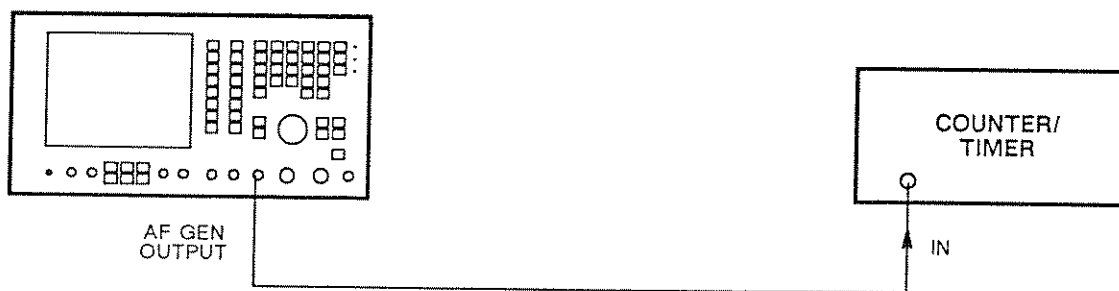

Fig. 6-14 Test equipment connections for AF generator frequency accuracy

DC offset

This section is used to check compliance with the following:-

DC offset: <10 mV.

The following test equipment is required:-

Description	Minimum specification	Example
DVM	DC down to 1 mV.	MI 2610

Proceed as follows:-

- (1) Connect the DVM to the AF GEN OUTPUT socket. See Fig. 6-15.

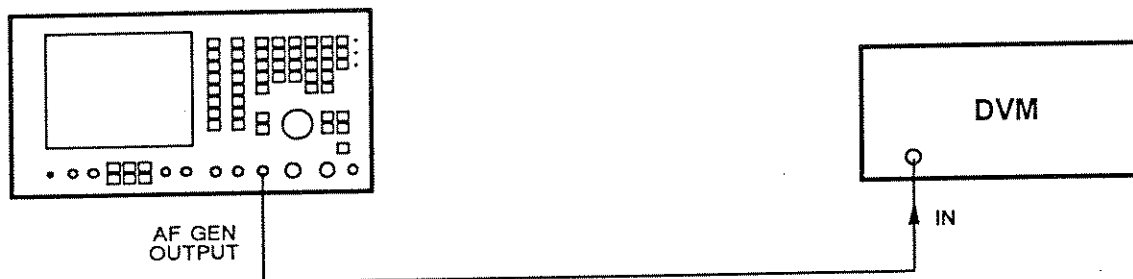

Fig. 6-15 Test equipment connections for AF generator DC offset

- (2) On the 2955B, set the MODE to AUDIO TEST. Ensure that GEN 1 is ON and GEN 2 is OFF. Press the TONES and AUDIO SETUP keys. Set the GEN 1 FREQ to 50 kHz, LEVEL to 0 mV and SHAPE to SINE.
- (3) Set the DVM to measure DC level.
- (4) On the DVM, check that the reading is <10 mV DC.
- (5) Reset the GEN 1 FREQ to other frequencies between 50 Hz and 15 kHz and repeat (4).

Residual noise

This section is used to check compliance with the following:-

Residual noise: <0.1 mV RMS in psophometric bandwidth.

The following test equipment is required:-

Description	Minimum specification	Example
Audio analyzer	SINAD, psophometric filter	HP 8903A or B

Proceed as follows:-

- (1) Connect the audio analyzer to the AF GEN OUTPUT socket. See Fig. 6-16.
- (2) On the 2955B, set the MODE to AUDIO TEST. Ensure that GEN 1 is ON and GEN 2 is OFF. Press the TONES and AUDIO SETUP keys. Set the GEN 1 FREQ to 50 kHz, LEVEL to 0 mV and SHAPE to SINE.
- (3) Set the audio analyzer to AC level with the psophometric band-pass filter on and all other filters off.
- (4) On the audio analyzer, check that the AC level reading is <0.1 mV RMS.
- (5) Reset the GEN 1 FREQ to other frequencies between 50 Hz and 15 kHz and repeat (4).

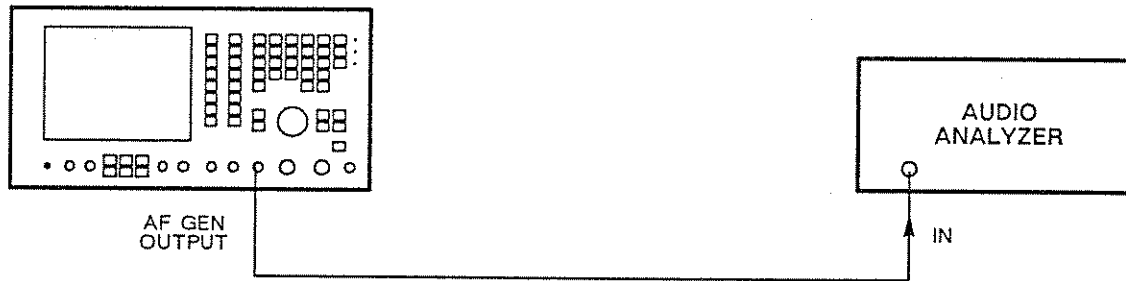

Fig. 6-16 Test equipment connections for AF generator residual noise

Waveform shapes

The following test equipment is required:-

Description	Minimum specification	Example
Oscilloscope	Frequency 20 kHz	Tektronix 2235

The 2955B's oscilloscope can be used but this gives slight degradation of the shapes.

Proceed as follows:-

- (1) Connect the oscilloscope to the AF GEN OUTPUT socket. See Fig. 6-17.
- (2) Set the oscilloscope to DC, 0.5 V/DIV, 0.2 μ s/DIV time-base.
- (3) On the 2955B, set the MODE to AUDIO TEST. Press the TONES and AUDIO SETUP keys. Ensure that GEN 1 is ON and GEN 2 is OFF. Set the GEN 1 FREQ to 1 kHz, LEVEL to 1 V and SHAPE to SQUARE.
- (4) On the oscilloscope, check for a square wave equal about ground of 4 divisions.
- (5) On the 2955B, set the SHAPE to TRIANGLE.

- (6) On the oscilloscope, check for a triangle waveform equal about ground of 4 divisions.
- (7) On the 2955B, set the SHAPE to SAW TOOTH.
- (8) On the oscilloscope, check for a saw-tooth waveform equal about ground of 4 divisions.

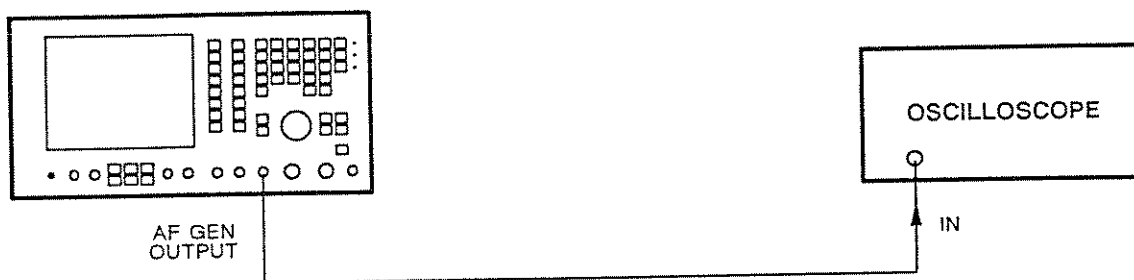

Fig. 6-17 Test equipment connections for AF generator waveform shapes

DTMF ENCODER AND DECODER

These can be checked by carrying out a back-to-back test.

Proceed as follows:-

- (1) Connect the AF GEN OUTPUT socket to the AF INPUT socket.
- (2) Press the RX TEST, AF GEN, TONES and DTMF keys to select the audio DTMF GENERATOR AND DECODER display.
- (3) Set the AF LEVEL to 500 mV and enter the following SEND DATA:-
 1 2 3 4 5 6 7 8 9 0 * # A B C D
- (4) Press the RECEIVE DATA CLEAR key.
- (5) Turn the volume control up slightly and press the SEND key. The tones should now be heard on the loudspeaker and should also appear decoded in the RECEIVE DATA window.

DISTORTION AND NOISE METER

Distortion

This section is used to check compliance with the following:-

Accuracy: $\pm 5\%$ of reading $\pm 0.5\%$ distortion.

The following test equipment is required:-

Description	Minimum specification	Example
Distortion meter	0.2% distortion at 1 kHz	MI 2331A

Proceed as follows:

- (1) Connect the AF GEN OUTPUT socket to the AF INPUT socket.
- (2) On the 2955B, set the MODE to AUDIO TEST, FILTER to 50 kHz LOW PASS and DIST'N. Press the TONES and AUDIO SETUP keys. Set AF GEN 1 FREQ to 1 kHz, LEVEL to 1 V and SHAPE to SINE. Set AF GEN 2 FREQ to 3.5 kHz, LEVEL to 206 mV and SHAPE to SINE.
- (3) Adjust the level of AF GEN 2 until the distortion meter reading is exactly 20.0%.
- (4) Remove the AF GEN OUTPUT from the AF INPUT and connect the distortion meter to the AF GEN OUTPUT socket. See Fig. 6-18.
- (5) Tune the distortion meter to 1 kHz and check that the reading is 18.5 to 21.5%.



Fig. 6-18 Test equipment connections for distortion and noise meter distortion

RF POWER METER

Level and frequency response

This section is used to check compliance with the following:-

Accuracy: $\pm 10\%$ ± 1 digit up to 500 MHz,
 $\pm 15\%$ ± 1 digit up to 960 MHz,
 $\pm 20\%$ ± 1 digit up to 1000 MHz.

The following test equipment is required:-

Description	Minimum specification	Example
Calibrated power source	Overall uncertainty of 2% up to 500 MHz, 3% up to 1000 MHz. The power source has to be calibrated at the frequencies which are to be used.	The five items which are detailed below.
Signal generator	1.5 to 1000 MHz, RF level 13 dBm.	MI 2019A
RF amplifier	1.5 to 1000 MHz, minimum 3 W, 40 dB gain.	MI TF2177 or Amplifier Research 5W1000
Directional coupler	1.5 to 1000 MHz, 20 dB coupling.	HP 778D (100 to 1000 MHz and Minicircuits ZFDC203 (1.5 to 100 MHz
Power meter and sensor	1.5 to 1000 MHz, ± 0.15 dB accuracy, -30 to +20 dBm.	MI 6960A and 6912

The power source is required to be a calibrated system with an overall uncertainty not greater than 2% up to 500 MHz and 3% up to 1000 MHz.

Proceed as follows:-

- (1) Connect the signal generator through the RF amplifier to the high frequency coupler. Connect the power meter through its sensor to the coupler. Connect the coupler output to the RF IN/OUT N socket. See Fig. 6-19.
- (2) On the 2955B, set the MODE to TRANSMITTER TEST and RF IN/OUT socket to N.
- (3) On the signal generator, set the frequency to 100 MHz and the level so that the reading on the power meter is 2 W.
- (4) Check that the TX POWER reading is the same as the power meter reading $\pm 10\%$ ± 1 digit.
- (5) On the signal generator, set the level so that the reading on the power meter is 220 mW.
- (6) Check that the TX POWER reading is the same as the power meter reading $\pm 10\%$ ± 1 digit.

ACCEPTANCE TESTING

- (7) Repeat (3) to (6) at other frequencies between 100 and 500 MHz.
- (8) Repeat (3) to (6) at other frequencies between 500 and 960 MHz except check that the TX POWER readings are the same as the power meter readings $\pm 15\%$ ± 1 digit.
- (9) Repeat (3) to (6) for other frequencies between 960 and 1000 MHz except check that the TX POWER readings are the same as the power meter readings $\pm 20\%$ ± 1 digit.

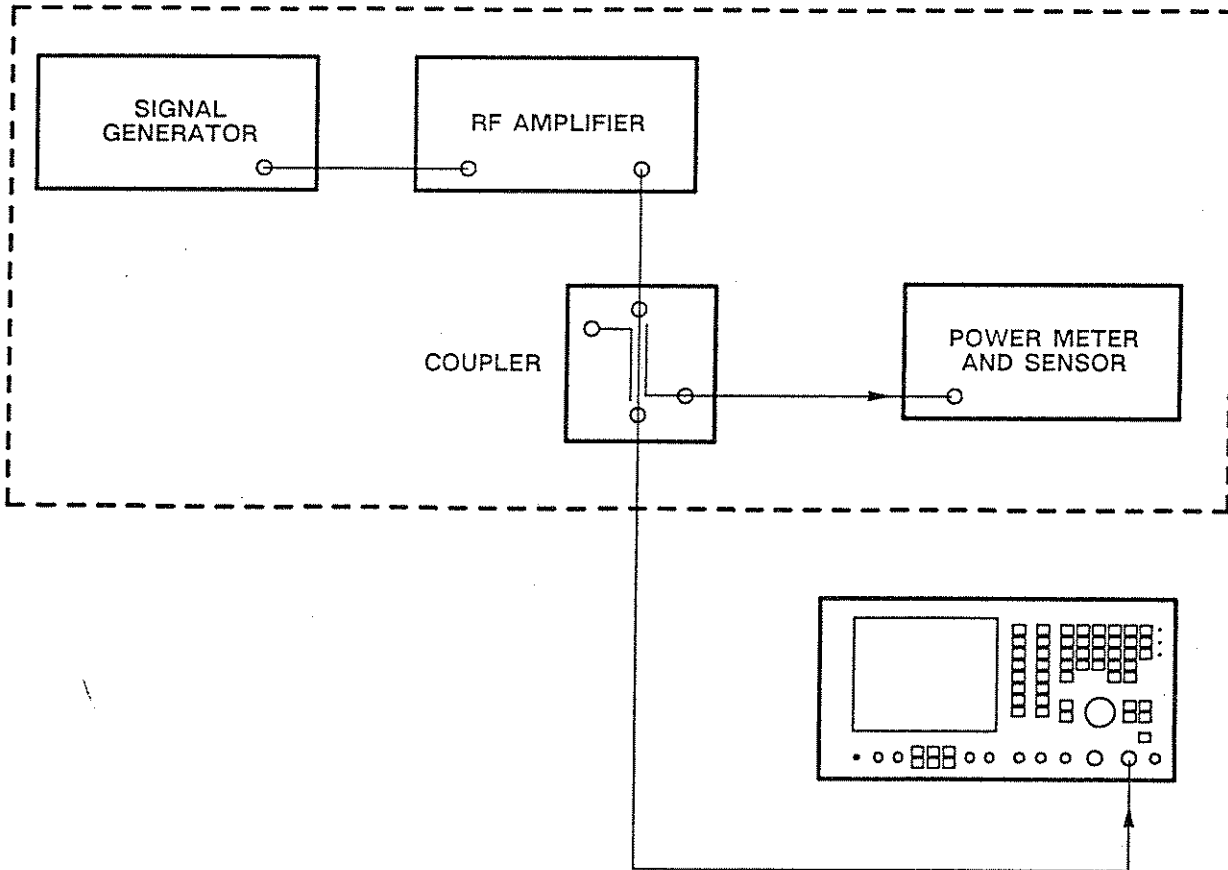

Fig. 6-19 Test equipment connections for RF power meter level and frequency response

- (10) Replace the high frequency coupler with the low frequency coupler.
- (11) Repeat (3) to (6) at other frequencies between 1.5 and 100 MHz.
- (12) On the 2955B, set the MODE to DUPLEX test and ONE PORT.
- (13) Repeat (3) to (11).

SEQUENTIAL TONES

Operation

The only test equipment required is a second 2955B.

Proceed as follows:-

- (1) Connect the RF IN/OUT BNC socket of the 2955B test instrument to the RF IN/OUT BNC socket of the 2955B under test. See Fig. 6-20.
- (2) On the 2955B under test, set the MODE to RECEIVER TEST, GEN FREQ to 100 MHz, LEVEL to 0 dBm, MOD to OFF and RF IN/OUT socket to BNC. Press the TONES, SEQUENTIAL and CCIR keys.
- (3) On the 2955B test instrument, set the MODE to TRANSMITTER TEST and RF IN/OUT socket to BNC. Press the TONES, SEQUENTIAL and CCIR keys.
- (4) On the 2955B under test, enter tone numbers 1 to 10 using the data keys. Press the TONE BURST key.
- (5) On the 2955B test instrument, check that the tones 1 to 10 appear with zero error.
- (6) Repeat (2) to (5) with the 2955B under test and the 2955B test instrument transposed.



Fig. 6-20 Test equipment connections for sequential tones

RF GENERATOR

Output level

This section is used to check compliance with the following:-

Accuracy: ± 1.8 dB for levels above -127 dBm
over temperature range 18 to 28°C.

The following test equipment is required:-

Description	Minimum specification	Example
Power meter and sensors	0.4 to 1000 MHz, -65 to 0 dBm, accuracy better than >0.15 dB	MI 6960A, 6920 and 6912
Spectrum analyzer	Frequency 100 MHz, ability to reduce noise floor below -96 dBm.	MI 2383

Checking at low low levels (less <-60 dBm) requires the use of specialised attenuator measurement equipment. Proceed as follows:-

- (1) Connect the power meter through its 6920 sensor to the RF IN/OUT N socket. See Fig. 6-21.
- (2) On the 2955B, set the MODE to RECEIVER TEST, GEN FREQ to 300 MHz, LEVEL to -20.5 dBm, INC to 1 dB, MOD to OFF and RF IN/OUT socket to N.
- (3) On the power meter, check that the reading is -20.5 dBm ± 1.8 dB.

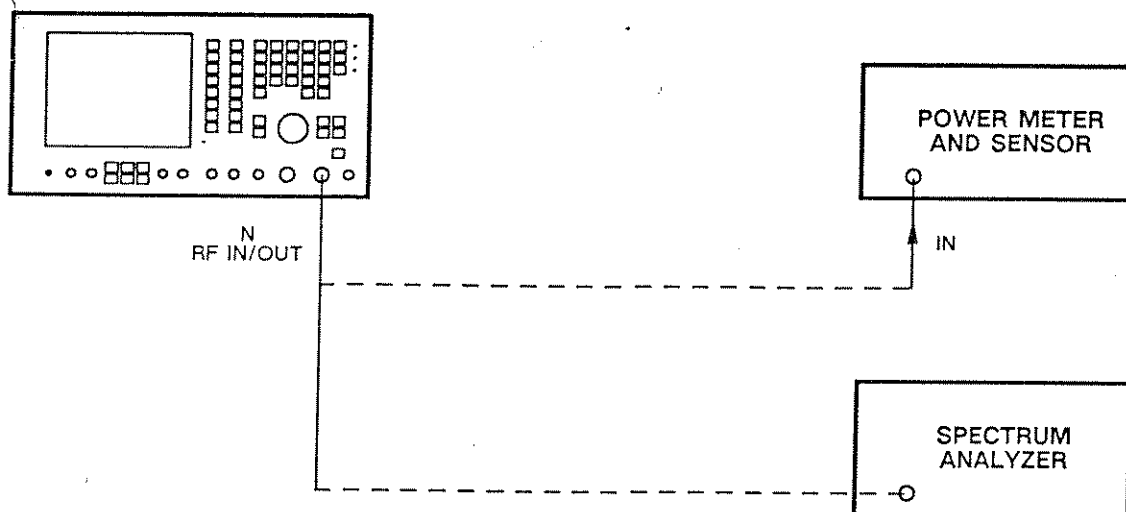

Fig. 6-21 Test equipment connections for RF generator output level

- (4) On the 2955B, decrease the LEVEL in 1 dB steps using the INCREMENT keys to -25.5 dBm.

- (5) On the power meter, check that each step is ± 1.8 dB.
- (6) On the power meter, check that the reading is ± 1.8 dB at the following levels and frequencies:-

Generator frequency	Level	Check
300 MHz	-26 dBm	Internal 10 dB pad
300 MHz	-36 dBm	20 dB pad in attenuator
300 MHz	-56 dBm	First 40 dB pad in attenuator
1000 MHz	-25 dBm	Flatness
10 MHz	-25 dBm	Flatness

- (7) Replace the 6920 head with the 6912 head.
- (8) On the power meter, check that the level at the following points is ± 1.8 dB:-

Generator frequency	Level
400 kHz	-15 dBm
20 MHz	-15 dBm
100 MHz	-15 dBm
300 MHz	-15.5 dBm
300 MHz	-16.5 dBm
300 MHz	-17.5 dBm
300 MHz	-18.5 dBm
300 MHz	-19.5 dBm
500 MHz	-15 dBm
1000 MHz	-15 dBm

- (9) Connect the spectrum analyzer to the RF IN/OUT BNC socket.
- (10) On the 2955B, set the GEN FREQ to 100 MHz, LEVEL to -96 dBm and RF IN/OUT socket to BNC.
- (11) On the spectrum analyzer, check that the level is -96 dBm. This checks that the last 40 dB of the attenuator is switching in correctly.

Frequency

This section is used to check compliance with the following:-

Accuracy: As internal standard.

The following test equipment is required:-

Description	Minimum specification	Example
Frequency counter	0.4 to 1000 MHz, 1 MHz standard output.	MI 2435

The following method is used to check that the frequency synthesizer is working correctly. However, overall accuracy depends upon the correct setting of the internal 10 MHz standard. Proceed as follows:-

- (1) Connect the frequency counter to the RF IN/OUT BNC socket. See Fig. 6-22.

- (2) On the 2955B, set the MODE to RECEIVER TEST, GEN FREQ to 1000 MHz, LEVEL to 0 dBm, MOD to OFF and RF IN/OUT socket to BNC.
- (3) Check that the counter reading is the same as the GEN FREQ setting ± 20 Hz.
- (4) Reset the GEN FREQ to other frequencies between 0.4 and 1000 MHz and repeat (3).

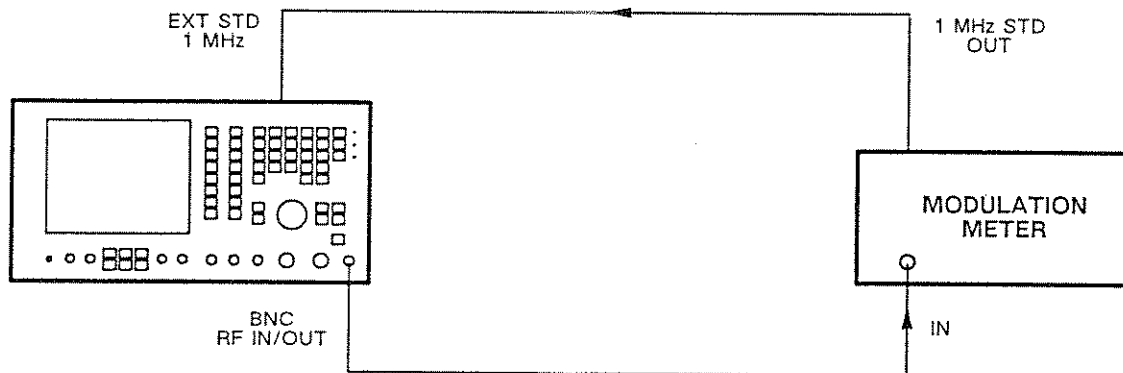

Fig. 6-22 Test equipment connections for RF generator frequency

AM depth

This section is used to check compliance with the following:-

Accuracy: $\pm 7\%$ of setting ± 1 digit at 1 kHz up to 85% AM,
 $\pm 10\%$ of setting ± 1 digit from 50 Hz to 5 kHz and 0 to 70% AM,
 $\pm 15\%$ of setting ± 1 digit from 50 Hz to 15 kHz and 0 to 85% AM.

The following test equipment is required:-

Description	Minimum specification	Example
AM modulation meter	0.5 to 1000 MHz, accuracy 1% at 1 kHz modulating frequency, 2.5% at 50 Hz to 15 kHz.	MI 2305

Proceed as follows:-

- (1) Connect the modulation meter to the RF IN/OUT BNC socket. See Fig. 6-23.
- (2) On the 2955B, set the MODE to RECEIVER TEST, GEN FREQ to 100 MHz, LEVEL to 0 dBm, MOD to AM, MOD FREQ to 1 kHz, LEVEL to 85%, DIST'N, S/N and SINAD to off and RF IN/OUT socket to BNC.
- (3) Set the modulation meter to AM in a 0.3 to 3.4 kHz bandwidth.
- (4) Check that the modulation meter reading is the same as the MOD LEVEL setting $\pm 7\% \pm 1$ digit.

- (5) Reset the MOD LEVEL to other levels between 0 and 85%, FREQ to other frequencies between 1.5 and 400 MHz and GEN LEVEL to other levels and repeat (4) except check that the modulation meter readings are the same as the MOD LEVEL settings $\pm 10\% \pm 1$ digit.
- (6) Reset the MOD FREQ to other frequencies between 50 Hz and 5 kHz and LEVEL to other depths between 0 and 70% and repeat (4) except check that the modulation meter readings are the same as the MOD LEVEL settings $\pm 10\% \pm 1$ digit.
- (7) Reset the MOD FREQ to other frequencies between 5 kHz and 15 kHz and LEVEL to other depths between 70% and 85% and repeat (4) except check that the modulation meter readings are the same as the MOD LEVEL settings $\pm 15\% \pm 1$ digit.



Fig. 6-23 Test equipment connections for RF generator AM depth and FM deviation

FM deviation

This section is used to check compliance with the following:-

Accuracy: $\pm 7\% \pm 10$ Hz at 1 kHz,
 $\pm 10\%$ at 50 Hz to 15 kHz.

The following test equipment is required:-

Description	Minimum specification	Example
FM modulation meter	0.5 to 1000 MHz, accuracy 2%.	MI 2305

Proceed as follows:-

- (1) Connect the modulation meter to the RF IN/OUT BNC socket. See Fig. 6-23.
- (2) On the 2955B, set the MODE to RECEIVER TEST, GEN FREQ to 100 MHz, LEVEL to 0 dBm, MOD to FM, MOD FREQ to 1 kHz, LEVEL to 25 kHz, SHAPE to SINE, DIST'N, S/N and SINAD to off and RF IN/OUT socket to BNC.
- (3) Set the modulation meter to FM in a 0.3 to 3.4 kHz bandwidth.
- (4) Check that the modulation meter reading is the same as the MOD LEVEL setting $\pm 7\% \pm 10$ Hz.

- (5) Reset the MOD LEVEL to other levels between 0 and 25 kHz, FREQ to other frequencies between 1.5 and 1000 MHz and GEN LEVEL to other levels and repeat (4) except check that the modulation meter readings are the same as the MOD LEVEL settings $\pm 10\% \pm 1$ digit.
- (6) Reset the MOD FREQ to other frequencies between 50 Hz and 15 kHz and repeat (4) except check that the modulation meter readings are the same as the MOD LEVEL settings $\pm 10\% \pm 1$ digit.

AM and FM distortion

This section is used to check compliance with the following:-

Distortion: <2% at 1 kHz with 30% AM in a 0.3 to 3.4 kHz bandwidth,
<1% at 1 kHz with 5 kHz FM in a 0.3 to 3.4 kHz bandwidth.

The following test equipment is required:-

Description	Minimum specification	Example
AM/FM modulation meter	Demodulated output.	MI 2305
Distortion meter	Accuracy better than 0.3% at 1 kHz.	MI 2331A

Proceed as follows:-

- (1) Connect the modulation meter input to the RF IN/OUT BNC socket. Connect the modulation meter output to the distortion meter. See Fig. 6-24.

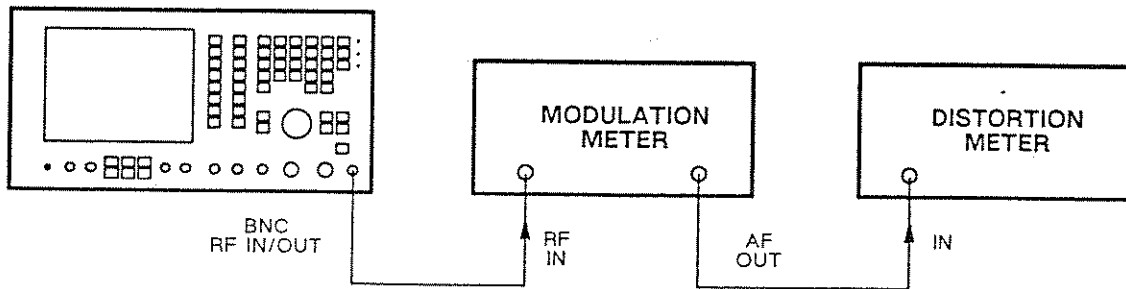

Fig. 6-24 Test equipment connections for RF generator AM distortion and FM distortion

- (2) On the 2955B, set the MODE to RECEIVER TEST, GEN FREQ to 100 MHz, LEVEL to 0 dBm, MOD to AM, MOD FREQ to 1 kHz, LEVEL to 30%, SHAPE to SINE, DIST'N, S/N and SINAD to off and RF IN/OUT socket to BNC.
- (3) Set the modulation meter to AM in a 0.3 to 3.4 kHz bandwidth.
- (4) Tune the distortion meter and check that the reading is <2%.
- (5) On the 2955B, reset MOD to FM, MOD FREQ to 1 kHz and LEVEL to 5 kHz.
- (6) Set the modulation meter to FM in a 0.3 to 3.4 kHz bandwidth.
- (7) Tune the distortion meter and check that the reading is <1%.

External AM and FM

This section is used to check compliance with the following:-

Sensitivity: 50 Hz to 5 kHz, up to 70% AM;
 1.5 V p-p for 30% AM $\pm 10\% \pm 1\%$ AM.
 1.0 V p-p for 5 kHz FM deviation $\pm 10\%$.

The following test equipment is required:-

Description	Minimum specification	Example
Modulation meter	1% AM accuracy at 1 kHz, 2.5% at 50 Hz to 15 kHz, 2% FM accuracy.	MI 2305
LF synthesizer	50 Hz to 15 kHz.	HP 3325A or B
DVM	0.5% accuracy.	Datron 1065A

Proceed as follows:-

- (1) Connect the LF synthesizer and the DVM to the EXT MOD INPUT socket. Connect the modulation meter to the RF IN/OUT BNC socket. See Fig. 6-25.
- (2) On the 2955B, set the MODE to RECEIVER TEST, GEN FREQ to 100 MHz, LEVEL to 0 dBm, MOD to AM, MOD FREQ to 1 kHz, MOD LEVEL to 0%, SHAPE to SINE, DIST'N, S/N and SINAD to off and RF IN/OUT socket to BNC.
- (3) Set the synthesized LF generator to give a 1 kHz sinewave output and adjust the level to give a DVM reading of 530 mV RMS (1.5 V p-p).
- (4) Set the modulation meter to AM in a 0.3 to 3.4 kHz bandwidth.
- (5) On the modulation meter, check that the reading is 30% $\pm 10\% \pm 1\%$ AM (i.e. 26 to 34%).
- (6) On the 2955B, reset MOD to FM, LEVEL to 0 kHz.
- (7) Set the synthesized LF generator to give a 1 kHz sinewave output and adjust the level to give a DVM reading of 353 mV RMS (1.0 V p-p).
- (8) Set the modulation meter to FM in a 0.3 to 3.4 kHz bandwidth.
- (9) On the modulation meter, check that the reading is 5 kHz $\pm 10\%$.
- (10) On the 2955B, reset MOD to AM, LEVEL to 0%.
- (11) Repeat (3) to (9) at other external modulating frequencies between 50 Hz and 15 kHz.

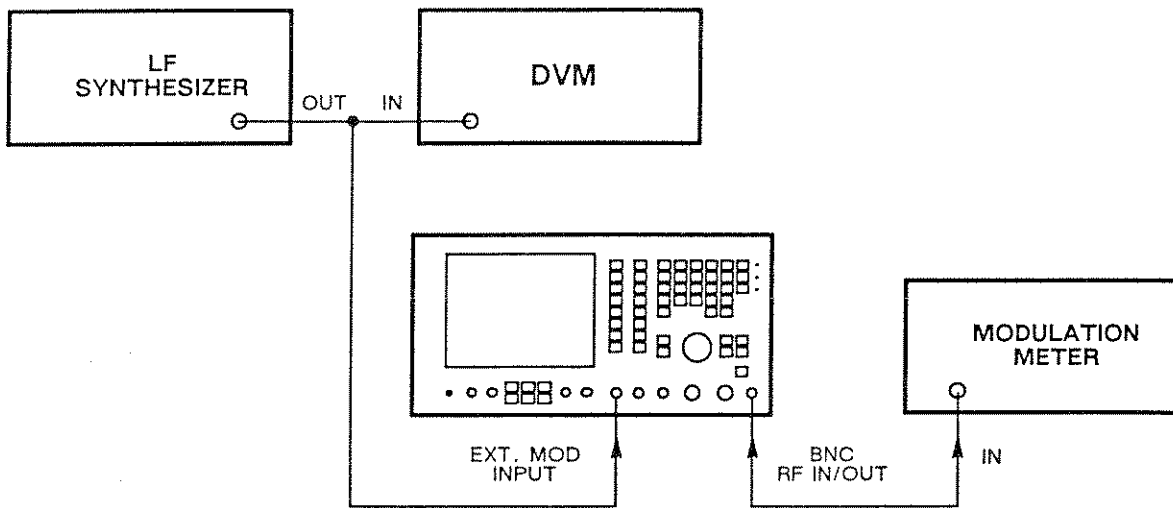

Fig. 6-25 Test equipment connections for RF generator external AM and FM

RF leakage

This section is used to check compliance with the following:-

Carrier leakage: <math> < 0.2 \mu V </math> PD generated in a 50 Ω load by a 2-turn 25 mm loop as near as 25 mm to the case of the instrument with the output set to <math> < -40 \text{ dBm}</math> and the output terminated in a 50 Ω sealed load.

The following test equipment is required:-

Description	Minimum specification	Example
Spectrum analyzer	0.4 to 1000 MHz.	MI 2383
Sealed load	50 Ω	-
2-turn 25 mm loop	-	-

Proceed as follows:-

- (1) Connect the spectrum analyzer to the loop. Connect the load to the RF IN/OUT BNC socket. See Fig. 6-26.

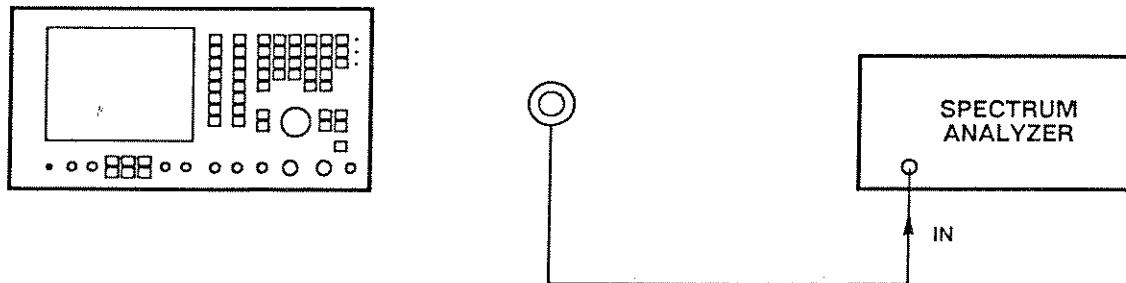

Fig. 6-26 Test equipment connections for RF generator RF leakage

- (2) On the 2955B, set the MODE to RECEIVER TEST, GEN FREQ to 501.9873 MHz, LEVEL to -40 dBm and RF IN/OUT socket to BNC.
- (3) Set the spectrum analyzer to 501.9873 MHz.
- (4) Hold the loop 25 mm away from the 2955B's case.
- (5) On the spectrum analyzer, check that the level picked up is $<0.2 \mu\text{V PD}$.

FM on CW

This section is used to check compliance with the following:-

FM on CW: $<13 \text{ Hz RMS}$ up to 500 MHz. $<26 \text{ Hz RMS}$ up to 1000 MHz.
(0.3 to 3.4 kHz weighted RMS).

The following test equipment is required:-

Description	Minimum specification	Example
Modulation meter	FM noise average, 0.3 to 3.4 kHz weighted filter.	MI 2305
Spectrum analyzer	0.4 to 1000 MHz, $<3 \text{ Hz p-p residual FM}$, IF output at 47 MHz	MI 2383

In this test, use is made of the 2383's low residual FM to down convert the 2955B's signal generator frequency to a 47.4 MHz IF. This allows the test to utilize the modulation meter in an area where the residual FM is $<1.4 \text{ Hz}$. Proceed as follows:-

- (1) Connect the modulation meter to the spectrum analyzer output and the spectrum analyzer input to the RF IN/OUT BNC socket. See Fig. 6-27.

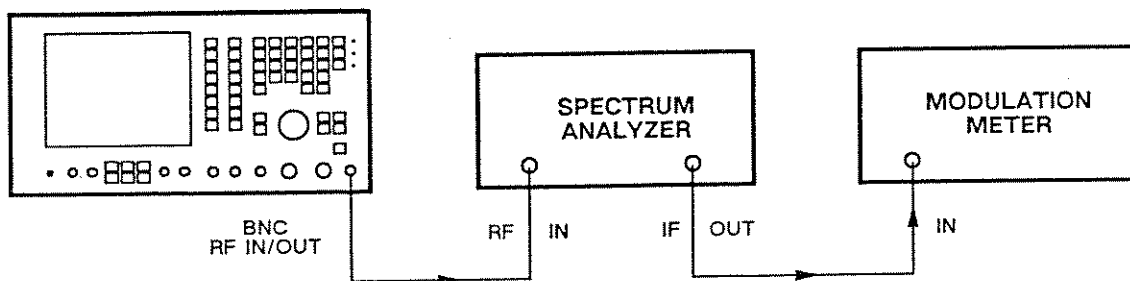

Fig. 6-27 Test equipment connections for RF generator FM on CW

- (2) On the 2955B, set the MODE to RECEIVER TEST, GEN FREQ to 500 MHz, LEVEL to 0 dBm, MOD to AM, MOD to OFF and RF IN/OUT socket to BNC.
- (3) Tune the spectrum analyzer to the same frequency as that set on the 2955B. Reduce the span/div to 100 Hz. If necessary retune and then select zero span. Adjust the input attenuation of the spectrum analyzer so that the IF level is adequate to excite the modulation meter.

- (4) Set the modulation meter to FM, with noise average in a 0.3 to 3.4 kHz bandwidth.
- (5) On the modulation meter, check that the reading is <18 Hz (13 Hz RMS).
- (6) Reset the GEN FREQ to other frequencies below 500 MHz and repeat (3), (4) and (5).
- (7) On the 2955B, reset the GEN FREQ to 1000 MHz and retune the spectrum analyzer.
- (8) On the modulation meter, check that the reading is <36 Hz (26 Hz RMS).
- (9) Reset the GEN FREQ to other frequencies between 500 and 1000 MHz and repeat (7) and (8).

Harmonics

This section is used to check compliance with the following:-

Harmonics: In band 0.4 to 1000 MHz only;
 <-20 dBc up to 1.5 MHz,
 <-25 dBc 1.5 to 250 MHz,
 <-20 dBc 250 to 1000 MHz.

The following test equipment is required:-

Description	Minimum specification	Example
Spectrum analyzer	0.4 to 1000 MHz.	MI 2383

Proceed as follows:-

- (1) Connect the spectrum analyzer to the RF IN/OUT BNC socket. See Fig. 6-28.
- (2) On the 2955B, set the MODE to RECEIVER TEST, GEN FREQ to 1.5 MHz, LEVEL to 0 dBm, MOD to AM, MOD to OFF and RF IN/OUT socket to BNC.
- (3) Adjust the spectrum analyzer to reference the 1.5 MHz fundamental on the top graticule line.
- (4) On the spectrum analyzer, check that the reading is <-20 dBc.
- (5) Repeat (4) at frequencies between 0.4 and 1.5 MHz. On the spectrum analyzer, check that the reading is <-25 dBc.
- (6) Repeat (4) at frequencies between 1.5 and 250 MHz. On the spectrum analyzer, check that the reading is <-25 dBc.
- (7) Repeat (4) at frequencies between 250 and 1000 MHz. On the spectrum analyzer, check that the reading is <-20 dBc.

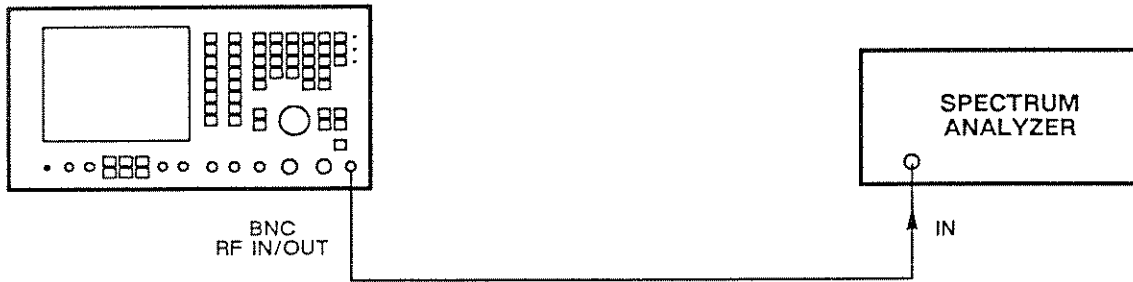

Fig. 6-28 Test equipment connections for RF generator harmonics, sub-harmonics and spurious signals

Sub-harmonics

This section is used to check compliance with the following:-

Sub-harmonics: None up to 530 MHz,
<-25 dBc to 1000 MHz.

The following test equipment is required:-

Description	Minimum specification	Example
Spectrum analyzer	0.4 to 1000 MHz.	MI 2383

Proceed as follows:-

- (1) Connect the spectrum analyzer to the RF IN/OUT BNC socket. See Fig. 6-28.
- (2) On the 2955B, set the MODE to RECEIVER TEST, GEN FREQ to 530 MHz, LEVEL to 0 dBm, MOD to OFF and RF IN/OUT socket to BNC.
- (3) Adjust the spectrum analyzer to reference the 530 MHz fundamental on the top graticule line.
- (4) On the spectrum analyzer, check that the reading is <-25 dBc.
- (5) Repeat (4) for frequencies between 530 and 1000 MHz.

Spurious signals

This section is used to check compliance with the following:-

Spurious signals: Carrier up to 88 MHz;
 <-45 dBc below 110 MHz,
 <-35 dBc above 110 MHz.
 Carrier up to 1000 MHz;
 <-60 dBc.

The following test equipment is required:-

Description	Minimum specification	Example
Spectrum analyzer	0.4 to 1000 MHz.	MI 2383

Proceed as follows:-

- (1) Connect the spectrum analyzer to the RF IN/OUT BNC socket. See Fig. 6-28.
- (2) On the 2955B, set the MODE to RECEIVER TEST, GEN FREQ to 88 MHz, LEVEL to 0 dBm, MOD to OFF and RF IN/OUT socket to BNC.
- (3) Adjust the spectrum analyzer to reference the 88 MHz fundamental on the top graticule line.
- (4) On the spectrum analyzer, check that the reading for spurious signals below 110 MHz is <-45 dBc and the reading for spurious signals above 110 MHz is <-35 dBc.
- (5) Repeat (4) at carrier frequencies between 0.4 and 88 MHz.
- (6) Repeat (4) at carrier frequencies between 88 and 1000 MHz. Check that the reading for all spurious signals is <-60 dBc.

Level

This section is used to check compliance with the following:-

Accuracy: Typically ± 3 dB at 100 MHz with reference to -60 dBm over the range -87 to -24 dBm ($10 \mu\text{V}$ to 14 mV) at the BNC socket or -67 to -4 dBm ($100 \mu\text{V}$ to 140 mV) at the N socket.

The following test equipment is required:-

Description	Minimum specification	Example
Signal generator	± 2 dB RF level accuracy over range -4 to -87 dBm at 100 MHz.	MI 2019A

Proceed as follows:-

- (1) Connect the signal generator RF output to the RF IN/OUT BNC socket. See Fig. 6-30.



Fig. 6-30 Test equipment connections for sensitive receiver level

- (2) On the 2955R, set the mode to TRANSMITTER MONITOR, the IF FILTER to 12 kHz, the TX FREQUENCY to 100 MHz and the RF IN/OUT to the BNC socket.
- (3) Set the signal generator to give a carrier of 100 MHz at a level of -60 dBm.
- (4) On the 2955R, press the dBm key for a STRENGTH reading in dBm. Check that the STRENGTH reading is -60 dBm ± 5 dB.
- (5) Press the dB key twice to give a STRENGTH reading of 0 dBR.
- (6) Set the signal generator to the following levels and check that the readings are within ± 5 dB of the correct reading:-

Signal generator level	Correct reading
-24 dBm	$+36$ dBR
-34 dBm	$+26$ dBR
-44 dBm	$+16$ dBR
-54 dBm	$+6$ dBR
-64 dBm	-4 dBR
-74 dBm	-14 dBR
-84 dBm	-24 dBR
-87 dBm	-27 dBR

SENSITIVE OFF-AIR RECEIVER (Option 1 only)

Sensitivity

This section is used to check compliance with the following:-

Sensitivity: $2 \mu\text{V}$ for 10 dB SINAD in 12 kHz bandwidth from 1 MHz to 1000 MHz for 3.5 kHz deviation in a psophometric bandwidth.

The following test equipment is required:-

Description	Minimum specification	Example
Signal generator	± 2 dB RF level accuracy at $2 \mu\text{V}$ for carrier frequency 1 to 1000 MHz; ability to provide 3.5 kHz deviation at 1 kHz rate.	MI 2019A
SINAD meter	10 dB SINAD measurement in a psophometric bandwidth at accuracy ± 1 dB.	HP 8903B & CCITT filter

Proceed as follows:-

- (1) Connect the signal generator RF output to the RF IN/OUT BNC socket. Connect the SINAD meter input to the DE-MOD OUT socket. See Fig. 6-29.

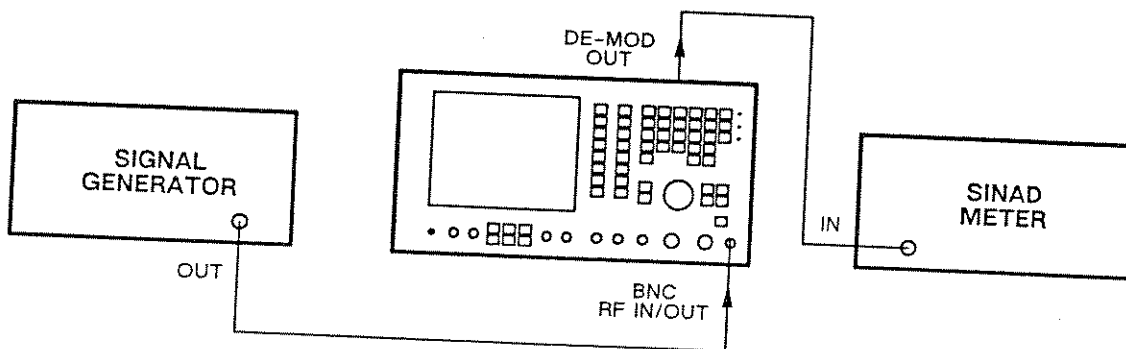

Fig. 6-29 Test equipment connections for sensitive receiver sensitivity

- (2) On the 2955R, set the mode to TRANSMITTER MONITOR, the IF FILTER to 12 kHz, the TX FREQUENCY to 10.02 MHz and the RF IN/OUT to the BNC socket.
- (3) Set the signal generator to give a carrier of 10.02 MHz at a level of $2 \mu\text{V}$ PD and 3.5 kHz FM deviation at 1 kHz rate.
- (4) Set the SINAD meter to read in a psophometric bandwidth.
- (5) On the SINAD meter check that the reading is >10 dB.
- (6) Repeat (5) at 100.02, 200.02, 300.02, 400.02, 500.02, 600.02, 700.02, 800.02, 900.02 and 999.02 MHz.

INDEX

	Page
Acceptance testing	2-5
ACCESSORIES	
Operation	3-8
Optional	1-23
Supplied	1-23
AF FREQUENCY METER	
Performance data	1-16
AF GENERATORS	
Audio testing	3-40
Performance data	1-11
Technical description	5-4
Transmitter testing	3-10
AF VOLTMETER	
Audio testing	3-44
Performance data	1-16
Receiver testing	3-29
Technical description	5-3
Applications	3-21
ASCII codes	4-9
AUDIO SETUP	
Audio testing	3-43
Duplex testing	3-37
Transmitter testing	3-13
AUDIO TESTING	
DTMF operation	3-64
Operation	3-39
Sequential tones operation	3-55
Battery pack	2-3
BX (BoX) commands	4-31
Connections	2-6
Character set	4-28
Command codes	4-9
Command format	4-8
Command input	4-24
Commands for the 2955B	4-7
Computer programs	4-24
Conventions	4-7
Data output	4-24
DCS ENCODER AND DECODER	
Operation	3-64
Performance data	1-19
Delimiters	4-7
DISTORTION METER	
Audio testing	3-46
Performance data	1-15
Receiver testing	3-31
Technical description	5-8
Transmitter testing	3-19

INDEX (continued)

	Page
DTMF ENCODER AND DECODER	
Operation	3-61
Performance data	1-19
DUPLEX TESTING	
DCS operation	3-66
DTMF operation	3-64
Operation	3-34
Sequential tones operation	3-55
Error codes	3-74
Front panel	3-5
GPIB controller programs	4-23
GPIB INTERFACE UNIT	
Installation... ..	2-2
Operation	4-3
Performance data	1-20
Graticule elements	4-31
HELP KEY	
Operation	3-69
Performance data	1-20
Initial settings	3-4
MODULATION GENERATOR	
Performance data	1-9
MODULATION METER	
Performance data	1-13
Technical description	5-6
Transmitter testing	3-16
MODULATION SETUP	
Duplex testing	3-37
Receiver testing	3-28
Mounting arrangements	2-3
NOISE METER	
Performance data	1-15
Receiver testing	3-31
Technical description	5-8
Transmitter testing	3-19
OFF-AIR RECEIVER	
Operation	3-76
Performance data	1-21
Technical description	5-10
Operating example	4-23
Operating summaries	3-69
OSCILLOSCOPE	
Display	3-5
Performance data	1-17

INDEX (continued)

	Page
Parameters	3-71
Performance data	1-8
POCSAG RADIO PAGER TESTING	
Operation	3-67
Performance data	1-19
POWER REQUIREMENTS	
Installation... ..	2-4
Performance data	1-21
Printer operation	3-86
Rack mounting	2-3
Rear panel	3-7
RECEIVER TESTING	
DCS operation	3-65
DTMF operation	3-62
Operation	3-22
Sequential tones operation	3-53
Reverse video characters	4-28
Revertive sequential tones operation	3-59
RF FREQUENCY METER	
Performance data	1-12
RF POWER METER	
Performance data	1-12
Technical description	5-5
Transmitter testing	3-14
RF SIGNAL GENERATOR	
Performance data	1-8
Receiver testing	3-24
Technical description	5-2
Safety testing	2-4
Screen commands	4-25
SELCALL (SEQUENTIAL TONES) ENCODER AND DECODER	
Operation	3-50
Performance data	1-18
Self testing	3-73
SENSITIVE RECEIVER	
Operation	3-76
Performance data	1-21
Technical description	5-10
SERIAL INTERFACE UNIT	
Installation... ..	2-2
Operation	4-5
Service requests... ..	4-25
SIGNALLING CODES TESTING	
Operation	3-48
Special features	1-6

INDEX (continued)

Status byte	4-25
Store and recall operation	3-84
Syntax	4-7
TONES MENU												
Audio testing	3-42
Duplex testing	3-37
Receiver testing	3-27
Transmitter testing	3-12
Transmitter frequency adjustment	3-21
TRANSMITTER MONITORING												
Operation	3-76
TRANSMITTER TESTING												
DCS operation	3-64
DTMF operation	3-62
Operation	3-9
Sequential tones operation	3-50
Unpacking and repacking	2-1
User-defined display examples	4-32
WR (WRite) commands	4-26

Use AF GEN OUTPUT to modulate Tx if required.
 Read modulation level on display.
 Demodulated signal can be heard on internal speaker or on earphones connected to ACCESSORY socket.
 Signal also available at DE-MOD OUT socket.
 Audio distortion and noise meter

Connect Tx modulating input to AF GEN OUTPUT.

Press and for RF IN/OUT socket.

Select modulation from or or .

Press for distortion reading on display.

Modulation frequency of 1 kHz and 0.3 to 3.4 kHz filter are automatically selected.

Press once or twice for up to 0.3 or 15 kHz.

Press for SINAD reading on display.

0.3 to 3.4 kHz filter is automatically selected.

Press once or twice for up to 0.3 or 15 kHz.

Press once or twice to return to 0.3 to 3.4 kHz or for an EXTERNAL filter (between DE-MOD OUT socket and AF INPUT socket).

Press again for S/N reading on display.

Select filter as for SINAD.

RECEIVER TESTING

RF generator

Press and for RF IN/OUT socket.
 Reverse overload makes display flash and sounds alarm.
 Enter frequency and level of RF generator.

e.g.

and

For increments of frequency and level, use to set, then Δ INCREMENT keys for increase or decrease.

Press for first modulation generator.

Press and for second generator.

Press to enable or disable selected generator.

When both are enabled, press and for first modulation generator.

For one or both generators, enter modulation frequency:

e.g.

For one or both generators, enter modulation level and type of modulation:

e.g. for FM deviation

and for AM depth

and for PM deviation radians.

For increments of frequency and level, use to set, then Δ INCREMENT keys for increase or decrease.
 Connect external modulation to EXT MOD INPUT.
 External modulation is added to internal modulation.

For external only, enter and any unit.

Audio distortion and noise meter

Connect Rx audio output to AF INPUT.

Press and for RF IN/OUT socket.

Set RF frequency and level as above.

Set modulation level and type as above.

Press for distortion reading on display.

Modulation frequency of 1 kHz, AC coupling and 0.3 to 3.4 kHz filter are automatically selected.

Press once or twice for up to 0.3 or 50 kHz.

Press for SINAD reading on display.

Modulation frequency of 1 kHz and 0.3 to 3.4 kHz filter are automatically selected.

Press once or twice for up to 0.3 or 50 kHz.

Press again for S/N reading on display.

Select filter as for SINAD.

DUPLEX TESTING

Press and for ONE PORT or TWO PORT as shown on the DUPLEX display.

Connect Tx modulating input to AF GEN OUTPUT.

Set AF generator as for 'Transmitter testing'.

Connect Tx output to RF IN/OUT N socket.

Connect Rx input to RF IN/OUT N (1-port) or BNC (2-port) socket.

Connect Rx audio output to AF INPUT.

Set RF generator frequency, level and modulation as for 'Receiver testing'.

Then proceed as for 'Transmitter testing' and 'Receiver testing'.

AUDIO TESTING

AF voltmeter

Connect audio unit to AF GEN OUTPUT and AF INPUT.

Press and for AUDIO TEST mode.

Set AF generators as for 'Transmitter testing'.

Read input voltage on display.

Press once or twice to add dBV or dBx reading

Press for AC or DC + AC.

Press for 0.3 to 3.4 kHz.

Press once or twice for 0.3 or 50 kHz.

Distortion and noise meter

Proceed as for 'Transmitter testing' except that LOW PASS filter is 0.3 or 50 kHz.

SIGNALLING CODES

Transmitter testing

Press and for RF IN/OUT socket.

Press to display TONES menu.

Select from and .

On SEQUENTIAL TONES MENU, select required standard: Trigger Tx to show TONE number, FREQ and % ERROR or TX SEQUENTIAL TONES menu.

On DTMF GENERATOR AND DECODER display, set AF generator LEVEL and, under SEND DATA, use , number keys and for sequence of digits. Under RECEIVE DATA, decoded digits are shown.

On DCS DECODER display, set MOD FREQ and POLARITY to show decoded signal and each address CODE.



RADIO COMMUNICATIONS Also applicable
TEST SET 2955A to 2955B
 0.4 to 1000 MHz
 46982-116A

TRANSMITTER TESTING

RF power meter and frequency meter

Press **TEST** and **RF IN/OUT** for RF IN/OUT socket. Sustained overload makes display flash and sounds alarm. Read power and frequency on TRANSMITTER TEST display.

For frequency OFFSET on display, enter datum frequency:
 e.g. **TEST** **RF IN/OUT** **1** **0** **RF IN/OUT**

AF generators

Connect Tx modulating input to AF GEN OUTPUT.

Press **TEST** and **AF GEN** for first AF generator.

Enter frequency of first AF generator:

e.g. **FREQ** **1** **0** **2** **3** **4** **RF IN/OUT**

Enter level of first AF generator:

e.g. **LEVEL** **5** **0** **RF IN/OUT**

Press **AF GEN** and **2** for second AF generator.

Enter frequency and level in same way.

Press **AF GEN** and **1** to return to first AF generator.

Press **ON** to enable or disable selected AF generator.

For increments of frequency and level, use **Δ** **INCR** to set, then **Δ** **INCREMENT** keys for increase or decrease.

Modulation meter

Press **TEST** and **RF IN/OUT** for RF IN/OUT socket.

Select modulation from **RF IN/OUT** or **EXTERNAL**.

Press **TEST** once or twice for 0.3 to 3.4 kHz or **EXTERNAL**.

Press **TEST** once or twice for 0.3 or 15 kHz.

Receiver testing

Press **RF IN/OUT** for RF IN/OUT socket.

Press **TEST** to display TONES menu.

Select from **SEQUENTIAL**, **DIMF**, **DCS** and **POCSAG**.

In **SEQUENTIAL TONES MENU**, select required standard or REVERTIVE.

In **RX SEQUENTIAL TONES** menu, use **NEXT TONE** and number keys to enter up to 11 tones on each of 3 pages.

Use **TO NE STEP**, **TO NE BURST** or **CONTINUOUS** to generate the sequence.

In **DTMF GENERATOR AND DECODER** display, set **MOD LEVEL** and under **SEND DATA**, use **CLEAR**, **LOAD**, number keys and **SEND** for sequence of digits. Under **RECEIVE DATA**, decoded digits are shown.

In **DCS GENERATOR** display, set **MOD FREQ**, sub-audible deviation **LEVEL** and **POLARITY** and use **CODE**, **ENTER**, number keys and **SEND** for address code (3 octal digits) until **STOP** is used.

In **POCSAG RADIO PAGER TEST** display, set pager's **RF REQ**, **RF LEVEL**, **MOD FREQ** and **MOD LEVEL**, and use **MOD**, **ENTER** and number keys for **RF** number, set **ADDRESS** and use **ERROES** and **CHANGE** to insert errors and use **SEND** to transmit signal.

Duplex testing

Press **TEST** and **SELECT** for **ONE PORT** or **TWO PORT**.

Press **TEST** to display **TONES** menu.

Select from **SEQUENTIAL**, **DIMF**, **DCS** and **POCSAG**.

For generating, proceed as for 'Receiver testing'.

Audio testing

Press **TEST** and **AF GEN** for **AUDIO TEST** mode.

For generating, connect audio unit to **AF GEN OUTPUT**.

Press **TEST** and then as under 'Receiver testing'.

For receiving, connect audio unit to **AF INPUT**. Press **TEST** and then as under 'Transmitter testing'.

AUDIO AND MODULATION SETUP

On a **TONES** menu, press **AUDIO SETUP**, **MOD SETUP** or **MOD/AF SETUP**. Select generator as under 'AF generators' or as for modulation setting under 'RF generator'.

Press **ON** to select enabled or OFF.

Press **LOCK** to lock level of GEN 2 to that of GEN 1. Press **SHAPE** to select SINE, SQUARE, TRIANGLE or SAWTOOTH. Press **EXT MOD** to show **EXT MOD INPUT FREQ** and **LEVEL** where applicable.

OSCILLOSCOPE DISPLAYS

Press **SCALE** and set **INTENSITY** and **POSITION** controls.

Press **←** or **→** to adjust **HORIZ** scale.

Press **↺** or **↻** to adjust **VERT** scale.

Press **↻** or **↻** for single **SWEEP** storage or repetitive on auto trigger.

STORE AND RECALL

Press **STORE** and number keys (01 to 26) for storage.

Press **RECALL** and same number keys to recall or 00 to recall settings at last switch-off or power failure.

HELP KEY OPERATION

Press **HELP** to display **HELP** menu.

Press a **MODE** key for an operating summary.

Press **CHANGE PARAMETERS** to display the parameters menu. Select any of the parameters and reset as required.

MARCONI INSTRUMENTS LIMITED
 Longcross, St Albans, Herts, AL4 0JN, England
 Telephone: (0702) 52922 Telex: 23350
 Fax: (0727) 57481